

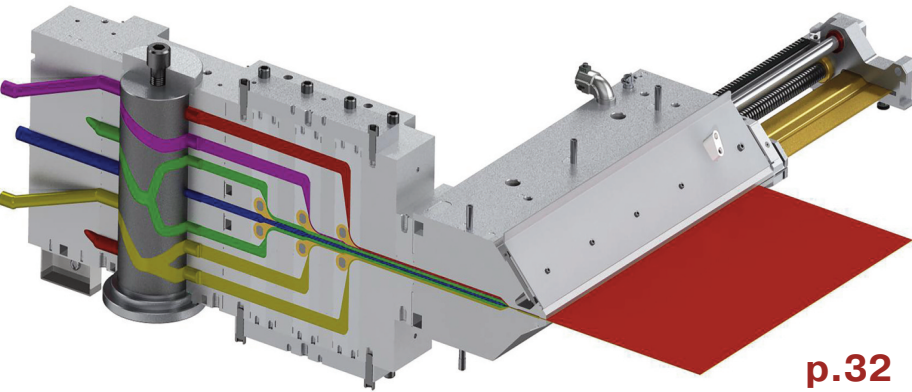

# EXTRUSION

# INTERNATIONAL

# ONLINE



p.32



p.16

p.28

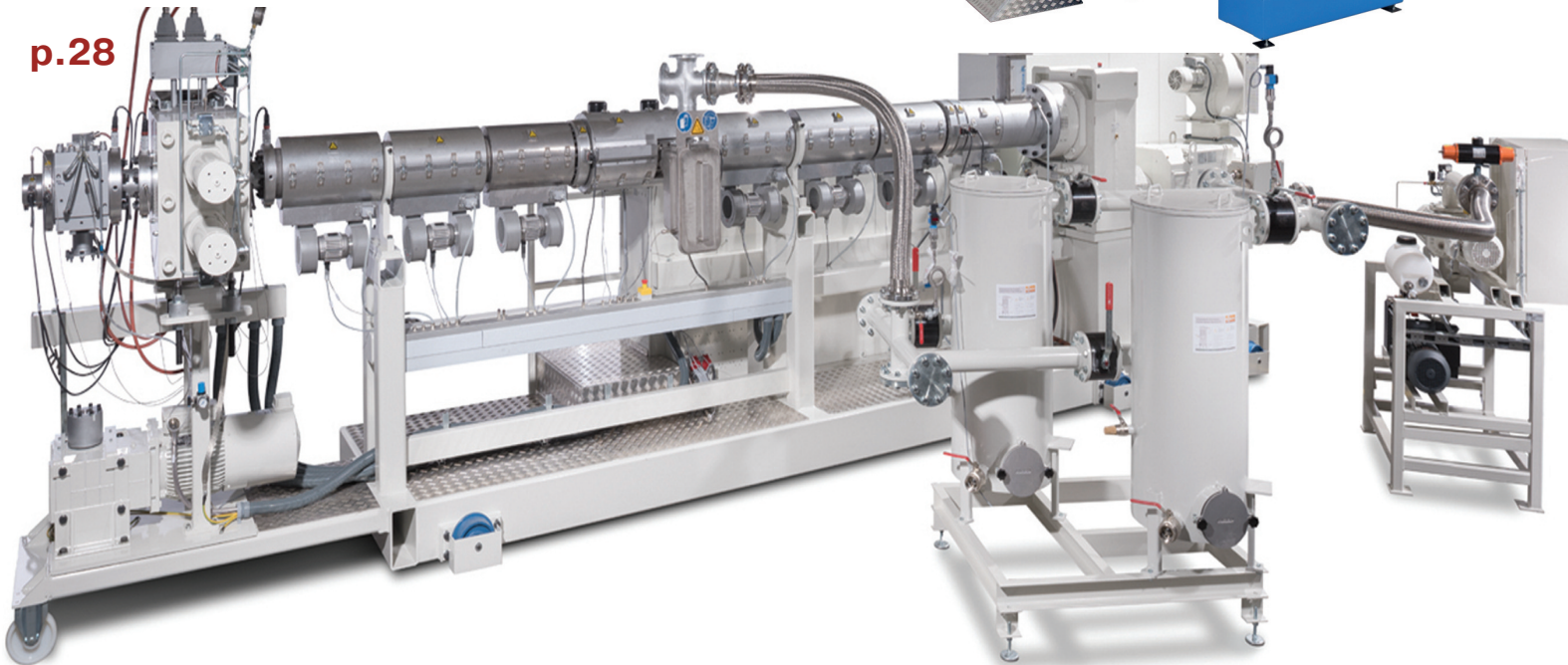

p.17

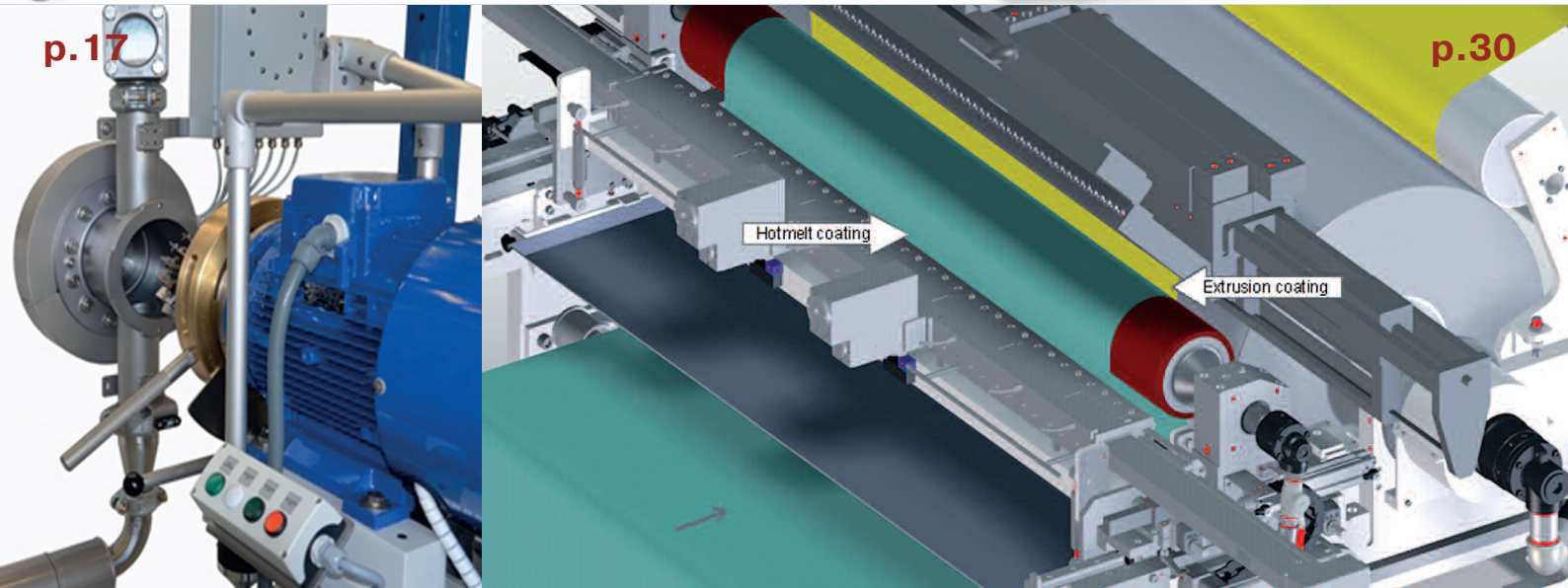

p.30

## The NEW generation of cutters for profiles



- Mirrored changing of the cutter angle during running production
- For optimised cutting of the respective profile
- Changing within 10 to 15 seconds, between two cuts
- Without loosening screws, by hand, with pneumatic clamping device using two retaining cylinders
- Sensational price thanks to increasing demand and manufacturing in large quantities

The cutter was manufactured for the first time in 1998 and in constant use throughout the world. They offer the absolute best cutting quality for glass strips, small profiles, main profiles and technical profiles.

Additional devices such as automatic film wrapping, measurement wheels for precise length determination or lettering with inkjet or laser printers can be attached.

**PTW-200**  
changeable cutting angle

Cutting Unit

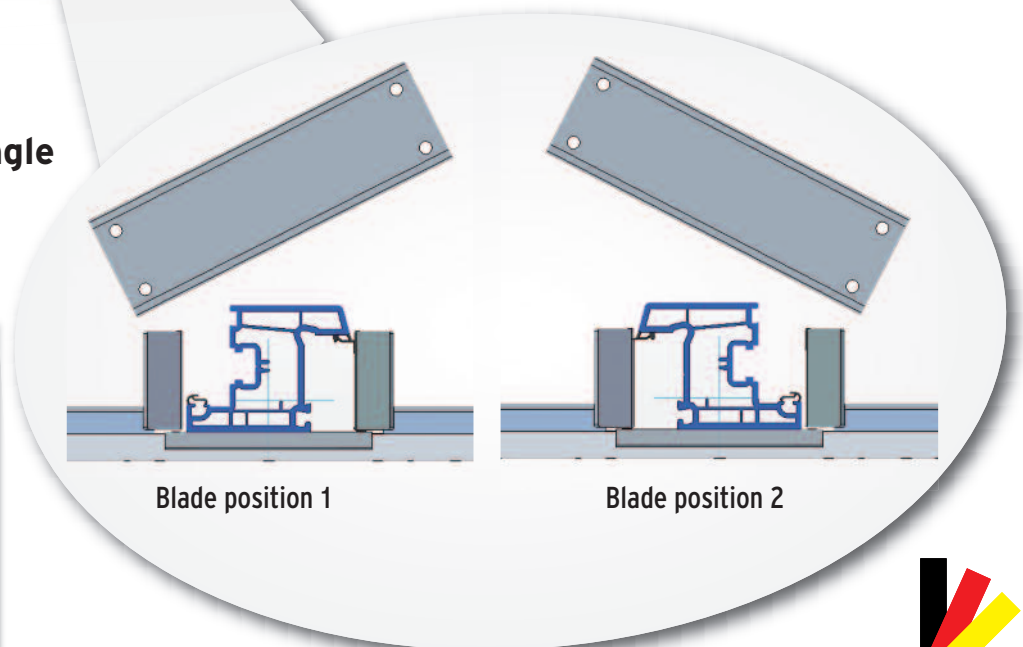
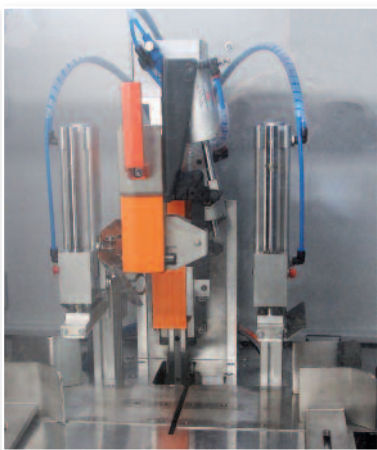

Blade position 1

Blade position 2



Made in  
Germany

# EQUIPMENT FOR EXTRUSION



## FOR PROFILE EXTRUSION LINES



Calibration table KTS 01,  
rear

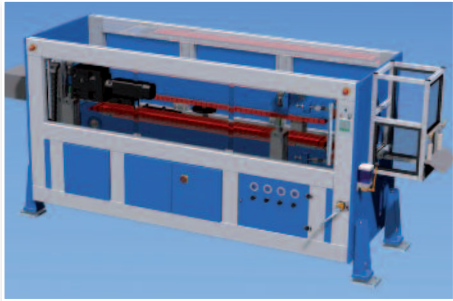

Caterpillar  
Haul off

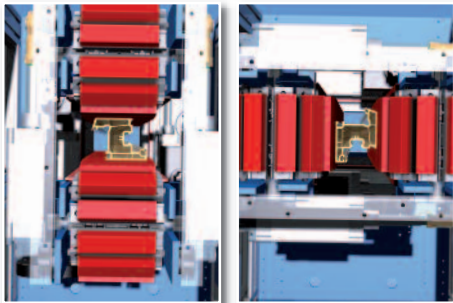

Haul off  
rotating 90°



PRO 63  
automatic stacker

## FOR SHEET EXTRUSION LINES



Calender



Roller withdrawal AZ 8,  
outlet side



Slitting RB 2 with four  
sawing stations



Transverse separating  
cutter QSS, inlet

**„STEIN BLUE-LINE – for a sustainable future“**  
stands for sustainable and energy-efficient equipment.  
Almost 100% domestic production and the high degree  
of manufacturing penetration guarantee compliance with  
even the most stringent of demands.

**STEIN Maschinenbau  
GmbH&Co.KG**

Wartbachstr. 9  
D-66999 Hinterweidenthal/Germany  
Tel. +49/63 96/92 15-0  
Fax +49/63 96/92 15-25  
stein@stein-maschinenbau.de ·  
www.stein-maschinenbau.de

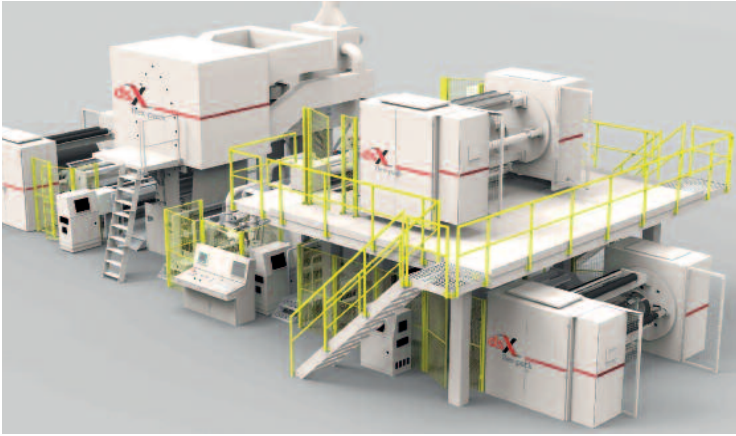

Davis-Standard's new technology and regional capabilities will be promoted at booth C01, Hall W1 during Chinaplas in Shanghai, April 25-28, 2016.

Davis-Standard has seen strong demand throughout Asia for feedscrews, control systems, medical tubing technology, and its dsX™ product line for cast film, blown film and packaging applications.

## Page 14

Firms in this issue	6	Low-Cost Automation for Basic Loading Needs	15
Imprint	7	KAMPF to deliver four machines for new BOPET plant to SRF	16
Industry News	8	After two takeovers	16
Reifenhäuser Blown Film sells five EVOLUTION Ultra Flat lines to Asia	8	Third generation of KCC machines go into production	18
Milacron Product Brands: All Under One Roof at Plastimagen	11	Tailored LFT compounds the reliable way	18
Asaf Eylon appointed General Manager of Tosaf's Additives, Whites and Compounds Division	11	10 Years celebrated	20
Successful change-over at BST ProControl GmbH	12	K 2016: Print@home saves time and money	21
COLINES acquires TORNINOVA	12	Surface treatment with maximum efficiency	22
World premiere large format lenticular lens drupa 2016	13	Kiefel buys Mould & Matic	22
Davis-Standard to Promote New Technology at Chinaplas	14	Windmüller & Hölscher shows newest innovations at Chinaplas 2016	23



Reifenhäuser Blown Film has sold five new lines to Asia within only six months. The company could convince above all with one thing: the high level of production efficiency. Reifenhäuser blown film lines are extremely reliable: They deliver products at a constant high level of quality while ensuring a zero error rate throughout the entire production process. In terms of quality, Reifenhäuser has been at the forefront since long. The engineers have consistently come up with new ideas to further optimize the film production process. The results are impressive.

## Page 8



On the occasion of the TecDay on 24 February 2016 in Hannover, KraussMaffei Berstorff exhibited their latest twin-screw extruder development – the ZE 65 BluePower Torque. Being designed for challenging requirements in high-performance compounding, this new machine generation is the ideal solution for customers who expect to achieve unparalleled quality and high performance combined with substantial energy savings.

## Page 26

AMUT for corrugated PVC sheet complete extrusion line	24	motan-colortronic shows the latest developments in the medical area during MEDTEC	36
Coperion Corporation relocates to new premises	24	Intelligente Kommunikation	38
First Bubble Guard® Board line hitting USA market	25	Thermoforming Line for Drinking Cups with IC-RDM 70K	39
ZE BluePower twin-screw extruders attract great interest from customers	26	"Grinders alone are no longer enough!"	40
Material and energy saving in thermoforming sheet, pipe and profile extrusion	28	Trends and developments in the Asian Flexible Packaging Market	44
New Technology for Breathable Products	30	IKV meets the world in Aachen	45
Flow control and versatility of coextrusion	32		
Versatile plant engineering for high quality LFT compounds	34		
Quality assurance during the extrusion of big tubes	35		

The new compounding extruder installed in the LFT development plant at Bensheim with its co-rotating, 26 mm diameter twin screws is designed for throughputs of up to 150 kg/h. Installed upstream of the extruder is a SOMOS® Gramix S gravimetric dosing system for accurately dosing and mixing of up to nine components.

## Page 34

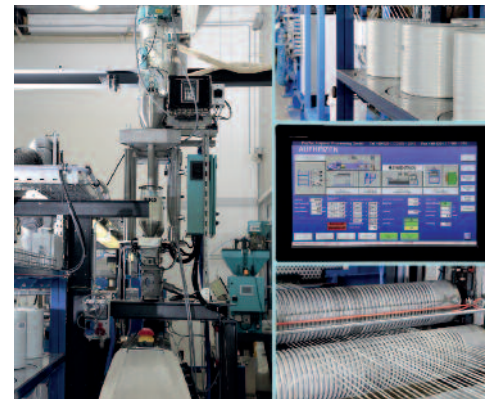

The ILLIG IC operating concept also supports the aspects relevant for large-volume production very effectively. Besides modules used for general process optimization, e.g. the self adaptive start-up (sas-up) during material or mold change, mainly IC modules are employed which ensure high productivity and reliability of a production line and at the same time help to minimize operation costs.

## Page 39

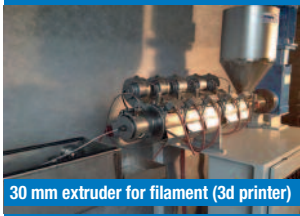

## Extruders & Extrusion facilities

**in stock • functionally tested • operational**

Visit our homepage  
with many used machines for the  
plastic extrusion business:

[www.pmh-extruder.com](http://www.pmh-extruder.com)

eMail:

[pmh.gmbh@t-online.de](mailto:pmh.gmbh@t-online.de)



**Plastic-Maschinen-Handelsges. mbH**  
Broichhausener Str. 4 · D-53773 Hennef  
Tel. +49-2244-83041 · Fax +49-2244-83045

### Index of Advertisers and companies referred in this issue

<b>A</b> MUT GROUP .....	24	KraussMaffei Berstorff .....	17+26
AZO .....	13	<b>m</b> aag .....	16+19
<b>b</b> attenfeld-cincinnati .....	28	Milacron .....	11
BST ProControl .....	12	MTI Mischtechnik .....	22
<b>C</b> olines .....	12+25	Molecor .....	20
Conair .....	15	motan-colortronic .....	7+36
Conextru .....	23	<b>N</b> ordson Kreyenborg .....	32
Coperion .....	24	<b>P</b> mh .....	6
<b>D</b> avis-Standard .....	14	ProTec .....	18+34
DPLenticular .....	13	<b>R</b> eifenhauser .....	8+15
<b>F</b> dm .....	21	Reifenhauser Blown Film .....	8
<b>G</b> etecha .....	40	Rosplast .....	25
<b>I</b> KV Aachen .....	45	<b>S</b> ikora .....	35
illig .....	20+39	SML .....	30
IPTF .....	U4	Stein .....	U2+3
<b>K</b> 2016 .....	21	<b>T</b> osaf .....	11
Kampf .....	16	<b>W</b> eber .....	9+10
Kautex Maschinenbau .....	18	Windmoeller & Hoelscher .....	23+44
Kiefel .....	22	<b>Z</b> umbach .....	38



The Extrusion International Digital/Print Magazine is published bimonthly by VM Verlag GmbH.  
P.O.Box 410907, D-50869, Cologne, Germany

#### EDITORS

*Alla Kravets (Project Manager, Digital Content)*  
Tel.: +49 2233 3909090  
a.kravets@vm-verlag.com

*Bettina Jopp-Witt (Content Coordinator)*  
Tel.: +49 221 5461539  
redaktion@vm-verlag.com

*Yury Kravets (Managing Editor)*  
y.kravets@vm-verlag.com

#### ADVERTISING SALES

*Inge Boehle (Sales Director)*  
Tel.: +49 721 700626  
i.boehle@vm-verlag.com

*Martina Lerner*  
Tel.: +49 6226 971515  
lerner-media@t-online.de

#### Reprints, Translation etc

No part of this publication may be reproduced, stored in a retrieval system, or transmitted, in any form or by any means, electronic, mechanical, photographic, recording or otherwise, without prior permission of the publisher.

[www.extrusion-info.com](http://www.extrusion-info.com)  
[www.plastcourier.publ.com](http://www.plastcourier.publ.com)  
[www.plastic.expert](http://www.plastic.expert)



motan®   
colortronic®

## ATTN DRIES GENTLY AT A CONSTANT DEW POINT

 think materials management

IND Chinaplas 2016 

Please visit us:  
25. - 28. 04. 2016  
Halle: E1, Booth: L41



#### LUXOR A 80-2400 - now with ATTN

ATTN brings more security in your drying processes. The automatic temperature and dew-point leveling is now available for all dryers in the Advanced (80–2400 m<sup>3</sup>/h) series. Setting a consistent dew-point prevents the over-drying of granulate. ATTN together with ETA plus® provides a useful system, that protects your material, ensures quality and saves you energy.

**motan-colortronic gmbh**  
info@motan-colortronic.de

[www.motan-colortronic.com](http://www.motan-colortronic.com)





### Medical Plastics 2016

25. – 26.04.2016,

Bangkok / Thailand

► TechnoBiz

[www.medicalplastics-expo.com](http://www.medicalplastics-expo.com)

### CHINAPLAS 2016

25. – 28.04.2016,

Shanghai / P.R.China

► Adsale Exhibition Services Ltd

[www.ChinaplasOnline.com](http://www.ChinaplasOnline.com)

### parts2clean

31.05 – 02.06.2016,

Stuttgart / Germany

► Deutsche Messe AG

[www.parts2clean.de](http://www.parts2clean.de)

### IPTF 2016

07. – 08.06.2016,

St.Petersburg / Russia

► FPR-Events

[www.iptf.ru/en/](http://www.iptf.ru/en/)

### ROSPLAST 2016

15. – 17.06.2016,

Moscow / Russia

► ООО «ЭМГ»

[www.rosplast-expo.com](http://www.rosplast-expo.com)

### ROSMOULD 2016

15. – 17.06.2016,

Moscow / Russia

► ООО «ЭМГ»

[www.ros mould.com](http://www.ros mould.com)

## Reifenhäuser Blown Film sells five EVOLUTION Ultra Flat lines to Asia

■ Reifenhäuser Blown Film has sold five new lines to Asia within only six months. The company could convince above all with one thing: the high level of production efficiency. Reifenhäuser blown film lines are extremely reliable: They deliver products at a constant high level of quality while ensuring a zero error rate throughout the entire production process. In terms of quality, Reifenhäuser has been at the forefront since long. The engineers have consistently come up with new ideas to further optimize the film production process. The results are impressive.

The patented EVOLUTION Ultra Flat film flattening unit integrated in the take-off is an essential module used to enhance the quality. Ultra Flat is able to correct surface irregularities occurring in the production of blown film. Surface irregularities are inherent to the film blowing process. They can occur to a greater or lesser extent in the production of packaging film, depending on film dimensions and structures. The resulting waves can cause serious problems in winding and conversion. Reifenhäuser Blown Film has the right solution: With EVOLUTION Ultra Flat a web of optimum flatness can be produced due to mi-



*EVOLUTION Ultra Flat take-off system optimizes the film flatness in blown film lines*

nimised stretching of the film via heating-cooling rolls - a prerequisite for winding and conversion on downstream equipment. Film producers around the world appreciate the Ultra Flat innovation. Especially the Asian market has responded to the newest Reifenhäuser technology with investments in the future: The first blown film line equipped with the Ultra Flat system came on stream in Vietnam about 22 months ago.

Further orders followed soon. The superior line configuration convinced both the owners and other interested customers outside Vietnam: Over the past six months Reifenhäuser recorded orders from Asia for a total of five new blown film lines equipped with the Ultra Flat flattening unit. Ultra Flat scores in many different respects: With an especially unproblematic conversion of the film, whether in laminating, printing, reforming, packaging or sealing operations. It enables the packaging industry to benefit from the increased efficiency throughout the whole value chain - thanks to webs of optimized flatness produced on Reifenhäuser Blown Film lines.

► [www.reifenhauser.com](http://www.reifenhauser.com)  
[www.reifenhauser-bf.com](http://www.reifenhauser-bf.com)



# Pipe extrusion

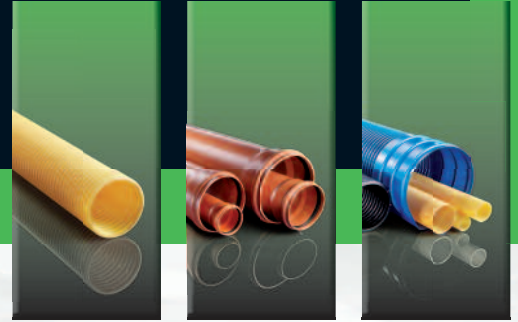

## The new DS 32 D series: Maximum performance for PVC pipe extrusion

**WEBER**  
*High Performance*  
DS 32 D Series

Once again WEBER set new standards in extrusion technology. The new extruder series DS 32 D, equipped with powerful drive technology and innovative screw technology, provides new impetus for PVC pipe manufacturing.

### Advantages of the *High Performance* DS 32 D series

- Compact, robust gearbox technology in WEBER quality
- High outputs even with smaller L/D ratio's
- More flexible applications through larger range of output
- Easy processing of high content PVC plastics
- Improved product quality even when using recycling materials
- Processing of cold mixtures



[www.hansweber.de](http://www.hansweber.de)

**WEBER**

# Pipe extrusion

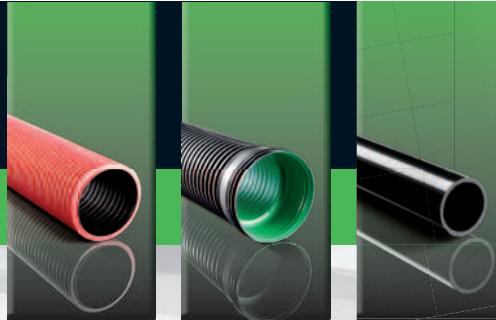

NE 7.40

## The NE 40 D series: Maximum performance for polyolefin pipe extrusion



WEBER have been building grooved bush extruders for more than five decades. A unique *High Performance* range was developed especially for extrusion of HDPE and PP pipes.

### Advantages of *High Performance* NE extruders

- Long effective life of grooved bush and processing unit through lower grooved bush pressure
- Constant output across the entire speed range
- Lower melt temperature compared to older machine concepts
- Output increase by up to 40 %
- Reduction of energy consumption
- Reduced water cooling of the grooved feed bush and new drive concept
- Torque motor optional



Booth No. E1E23



**WEBER**  
GREEN  
TECHNOLOGY

Hans Weber  
Maschinenfabrik GmbH  
Bamberger Straße 19 – 21  
96317 Kronach · Germany  
Post Box 18 62  
96308 Kronach · Germany  
Phone +49 (0) 9261 409-0  
Fax +49 (0) 9261 409-199  
info@hansweber.de  
www.hansweber.de

**WEBER**

## Milacron Product Brands : All Under One Roof at Plastimagen

■ On display at the Milacron Holdings Corp. (NYSE: MCRN) booth at Plastimagen 2016, in Mexico City have been presented technologies from Milacron's industry leading product brands including Milacron injection and extrusion molding, Mold-Masters hot runners and control systems and DME mold components and industrial supplies.

### Extrusion Technologies

Milacron both designs and builds full extrusion systems in house. Milacron's breadth of extrusion offerings is all encompassing, from extruders, to new and rebuilt extrusion barrels and screws, to pipe heads, dies and downstream equipment, providing powerful, reliable solutions that meet customers' unique needs. Milacron's extrusion solutions are highly customizable and increase productivity, output and accuracy, while reducing costs. Milacron's TP 75 Twin Screw Extruders (photo) combines space-saving compact design with the long proven advantages of Milacron technology for all your extrusion applications, including PVC pipe, foam PVC sheet, fence, vinyl profiles, wood and natural fiber plastic composites, vinyl siding and pelletizing. Our five parallel twin screw extruders cover application requirements for high throughputs. The complete line features proven advantages of minimal screw deflection and a large feed zone for maximum feeding efficiency. Screws have a high surface area for gentle, uniform heat transmission to produce a high-quality homogeneous melt.



### Highlights:

- Robust Eisenbeiss "Torquemaster" gearbox
- Segmented barrel design available in nitride and exclusive high wear-resistant tungsten coating
- Customized screw designs available with moly or exclusive high wear-resistant tungsten screw flight coatings

► [www.milacron.com](http://www.milacron.com)

## Asaf Eylon appointed General Manager of Tosaf's Additives, Whites and Compounds Division

*Asaf Eylon, newly appointed General Manager of Tosaf's Additives, Whites and Compounds activities*



■ Tosaf (Haifa, Israel) has appointed Asaf Eylon, 41, as new General Manager of the company's Additives, Whites & Compounds activities. Eylon started his career at Tosaf in 2005, holding various sales positions within the company, managing the colour masterbatch plants in Turkey and Belgium and until recently serving as Vice President International Sales & Marketing.

"This is an exciting challenge which I am very much looking forward to", says Eylon. "Tosaf's prominent position in the plastics industry with global market presence, a professional team and state-of-the-art equipment provide an excellent basis to take the company to new heights."

And Amos Megides, Tosaf Chairman of the Board, adds: "Asaf Eylon has gained extensive experience in the plastics industry while working in various high profile businesses where product and service quality are crucial. We are convinced that he will go on to develop and maintain these high standards in his new position at Tosaf, and we wish him all the best in his new position."

► [www.tosaf.com](http://www.tosaf.com)

## Successful change-over at BST ProControl GmbH

■ Successful change-over for BST ProControl GmbH in Wenden/Germany: Since January 2016, a new management team is in charge of the measurement specialist's business under the guidance of Managing Director Dr. rer. pol. Gunter Taurorus.

BST ProControl GmbH moves ahead at full speed with Dipl.-Ing. Kay Kuhlmann, responsible for sales and marketing issues, Dipl.-Ing. Geritt Block, head of the technological area and Markus Babel, certified electrical engineering technician and head of service. The dynamic trio is not only linked through the common challenge, but rather by a successful joint past under the umbrella brand Protagon Process Technologies GmbH, which was merged in 2012 with betacontrol GmbH – resulting in BST ProControl GmbH. Since the new formation in fall 2012, the team was able to prove repeatedly their expertise in the field of non-contact measuring and quality control of flat materials.



*Dipl.-Ing. Geritt Block, Dipl.-Ing. Kay Kuhlmann and Markus Babel*

Dr. Gunter Taurorus acts since 2014 as the Managing Director of BST eltromat International and is responsible for the sectors controlling and finances, human resources, IT as well as the supervision of subsidiaries. Dr. Gunter Taurorus was in charge of the eltromat group as executive partner from 1989 to 2014.

► [www.bst-procontrol.com](http://www.bst-procontrol.com)

## COLINES acquires TORNINOVA

*Massimo Mencarelli, CEO of TORNINOVA and Eraldo Peccetti, President and CEO of GRUPPO COLINES® HOLDING*



■ GRUPPO COLINES® HOLDING, a company based in Nibbia - San Pietro Mozzese (Novara), active in the production of lines and machinery for plastics processing, has finalized a business branch lease agreement aimed at the acquisition of the sector of the company TORNINOVA Srl in Bastia Umbra (Perugia) – represented by Mr Massimo Mencarelli, CEO - dedicated to manufacturing, assembling and maintenance of equipment for producing plastics materials in general and, in particular, air-bubble film.

GRUPPO COLINES® HOLDING, already a key player in the global market with its subsidiaries COLINES® SpA and ELAV® Srl, operating with a production range including eight sectors, thanks to this integration intends to strengthen also its predominant global sales volume – besides its technological superiority - in the field of machinery for producing protective air-bubble film. "This operation - as commented by Eraldo Peccetti, President and CEO of GCH – expresses a perfect combination and substantial synergy between the high technology of the machinery for air-bubble film - and not only - designed and sold by COLINES® since the early '70s and the large number of lines for the same application designed and sold by TORNINOVA since the '90s all over the world".

► [www.colines.it/extrusion-lines/en](http://www.colines.it/extrusion-lines/en)

## World premiere large format lenticular lens at drupa 2016

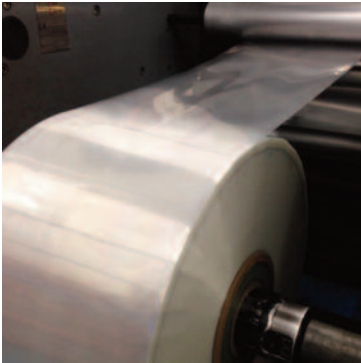

■ Dun Laoghaire, Ireland - DP Lenticular, the only European company dedicated solely to the promotion and sale of lenticular plastic sheets and rolls for the offset, digital and label markets, will be presenting its creative portfolio of solutions,

including a world first, at drupa from May 31 to June 10, 2016 at the Messe Düsseldorf. As the sole producer of large format lenses made in Europe, DP Lenticular, will place the spotlight firmly on its new 3D 28 LPI UV-MF. With a thickness of 2.15 mm and a viewing angle of 37°, it is the perfect match for three-dimensional lenticular applications printed on medium format digital systems. It joins the large format 3D 20 LPI UV-LF. Both are extruded in Europe with PETG-UV resin making them ideal for indoor use such as airports, subways, railway stations and outdoor use such as bus shelters. Extruded with a specially developed UV protection resin to preserve colors, PETG-UV is also fire-resistant and offers a much better transparency than other resins. At drupa, DP Lenticular will be partnering with KBA for live demos to the offset market. Show stopping prints will be produced on their new half format press using LENSTARplus® 75 LPI lenticular sheets.

The LENSTARplus® lenticular sheet is a PACUR product created specifically for direct lens printing that provides unsurpassed characteristics in brightness, toughness, clarity, notch resistance and cutability. All the Lenstar® and EcoLens® products are extruded by Pacur in Oshkosh WI (U.S.A) Developed specifically for the brand authentication, security, philatelic and other high-end flexible label markets, MicroFlex® labels will also be on display at the show. Produced by Forward Optics (U.S.A) MicroFlex® is a unique ultra-thin lens array film and the first ever label of this thickness to produce eye-catching depth, dimension, and motion effects. This unique substrate contains a micro-optical lens array on the surface magnifying graphic elements imbedded in the second surface printing. Unlike traditional lenticular material which is too stiff for most labeling applications, MicroFlex® is a patent pending blend of a biaxial oriented polypropylene base layer (for press stability) and cast polypropylene (for flexibility).

All products are designed and manufactured so that printers can print the interlaced (and reversed) image directly onto the gloss surface of the lenticular sheet (backside) using conventional or UV inks.

► [www.DPLenticular.com](http://www.DPLenticular.com).



**Automatic raw material handling in continuous processes**

## Automatically continuous

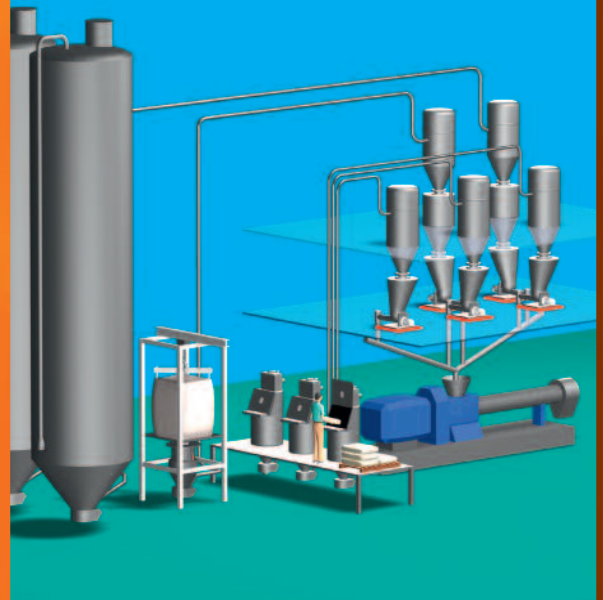

### AZO® solutions for the continuous process:

- control optimized
- highest accuracy
- reliable

**AZO®. The No. 1 in mixer feeding**



Visit us in Shanghai:  
April, 25 – 28, 2016  
Hall E1, Booth E1B13

**AZO®**

**[www.azo.com](http://www.azo.com)**

## Davis-Standard to Promote New Technology at Chinaplas

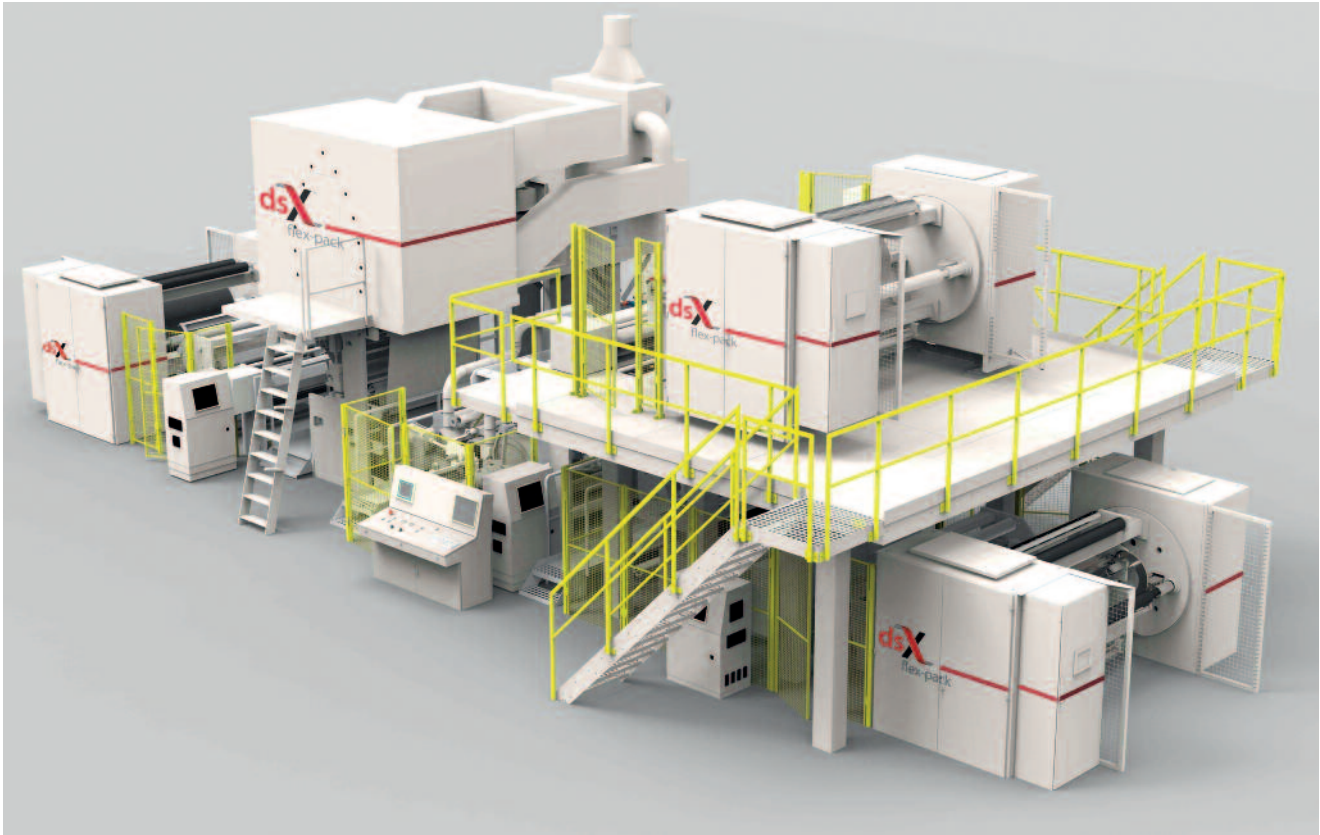

■ Davis-Standard's new technology and regional capabilities will be promoted at booth C01, Hall W1 during Chinaplas in Shanghai, April 25-28, 2016. Davis-Standard has seen strong demand throughout Asia for feedscrews, control systems, medical tubing technology, and its dsX™ product line for cast film, blown film and packaging applications. Davis-Standard's regional presence has continued to grow since opening a subsidiary in Suzhou two years ago. This facility is Davis-Standard's manufacturing base in China and houses an R&D laboratory for process development and trials. Davis-Standard will also promote the expansion of its film technology and aftermarket services with the recent acquisition of Gloucester Engineering. The medical tubing sector is one of Davis-Standard's strongest markets in China. The lab in Suzhou has been instrumental in supporting customers in this segment. The lab features direct-drive 19mm and 24mm single screw extruders, each with a polymer melt pump, a sophisticated three-layer spiral flow tubing die, PLC line control with data acquisition, precision vacuum sizing tank for both rigid and flexible products, closed loop ID/OD control via an ultrasonic gauging system, a servo controlled combination puller/cutting system, and a transport conveyer with single-zone air eject. It also includes a single layer tubing line designed specifically for the production of FPVC tubing for IV & fluid delivery applications. Products ranging in size from 2mm OD to 10mm OD can be produced with an accuracy of +/- 50u

at line speeds up to 100mpm. Davis-Standard's facility in Pawcatuck, Connecticut, also has a fully equipped medical tubing laboratory.

Both labs support applications for alternate polymer, microbore tubing, multi-lumen and catheter tubing, endotracheal and tracheotomy tubing, radio opaque tubing, bubble tube, taper tube, pipette tubing and multi-layer tubing, among others. Turn-key medical tubing systems support extruder outputs up to 700 pounds per hour (315kg/hr) and line speeds up to 800 feet per minute (240 mpm) for a range of materials including PLA, PLLA, PEEK, FPVC, polyurethane, nylon, PEBAX and FEP. Extruder options are available depending on process and application and engineered for a fast delivery and competitive pricing.

Another area of strength has been the sale of Davis-Standard's dsX™ machines. These have been well received throughout Asia due to a competitive advantage in price, performance and delivery. Davis-Standard offers these machines for cast film, blown film and extrusion coating applications. Demand has been especially strong for the dsX flex-pack™ (extrusion coating) due to continued demand for flexible packaging applications. This machine is built for cost-sensitive flexible packaging applications where fast and reliable production is essential.

► [www.davis-standard.com](http://www.davis-standard.com)



*New EZLoad Series single-tube loaders from Conair offer processors simple, reliable, and low-cost solutions for a range of everyday, point-to-point material conveying and loading applications*

## Low-Cost Automation for Basic Loading Needs

optional 1.3-hp brushless motor that boosts throughput to 1000 lbs/hr. at distances up to 120 ft (36.6 m).

For direct feed applications, EZLoad loaders can also be equipped with optional hoppers that mount directly to a machine throat. The EZLoad 2 can mount to glass hoppers in three sizes (3 lb, 11 lb, or 21 lb) or to a 10-lb stainless-steel hopper, while the EZLoad 5 can be mated to 20 or 40 lb stainless-steel hoppers.

➔ [www.conairgroup.com](http://www.conairgroup.com)

■ New EZLoad Series single-tube loaders from Conair offer processors simple, reliable, and low-cost solutions for a range of everyday, point-to-point material conveying and loading applications. Based on the proven design of Conair's popular Access series loaders, EZLoad loaders offer the same angled canister design and hinged filter lid that tilts back and locks to enable easy access for cleaning or filter maintenance. The new EZLoad control was specifically developed to serve loading applications where advanced load-control features are not necessary. There's no programming required. Once it is turned on, the EZLoad control manages load and dump times automatically. A standard reed switch located on the base of the loader indicates demand, while the EZLoad control automatically adjusts loading time based on resin bulk density to ensure complete hopper fill. The control also features a horn to notify the operator of a material-out situation. EZLoad Series loaders are available in two models, with three vacuum motors available to meet varied conveying distance and throughput requirements. Each top-mounted vacuum motor is contained in a sound-dampening plastic housing.

- The smaller EZLoad 2 loader features a 5/8-hp motor to provide throughputs up to 200 lbs/hr (90 kg/hr) over distances up to 50 ft (15.2 m).

- The larger EZLoad 5 model can be equipped with a 7/8-hp motor that handles up to 500 lbs/hr. (227 kg/hr) at distances up to 75 ft (22.9 m), or an



# Rethinking Technology

Questioning current solutions. Trying out new perspectives. Looking for new approaches. In the largest know-how network for extrusion technology we think different to develop true innovations – for clear competitive advantages in the production of high-quality blown films, cast films, sheets, monofilaments, strapping tapes and nonwovens.

Find more information about us online on [www.reifenhäuser.com](http://www.reifenhäuser.com)

You have questions?  
[info@reifenhäuser.com](mailto:info@reifenhäuser.com)

## KAMPF to deliver four machines for new BOPET plant to SRF



■ SRF Limited, a leading supplier for technical textiles, fluorine chemicals, specialty chemicals, engineering plastics and packaging films is setting up a new BOPET plant in India. The plant will produce up to 30,000 tons of BOPET film per year. The capacity for metallized film will be 8000 tons per year. More than 60% of the proposed project output of flexible packaging will be used in the food packaging and beverages industries. KAMPF will deliver four machines to SRF for this green field project. Beside one new Imperial non-stop winder there are three high performance slitters - one slitter type Universal for material widths up to 8,700 mm, and two slitters type Unislit II for materials widths up to 3,050 mm. Installation and commissioning of the machines in Indore, Madhya Pradesh will take place in the final quarter of 2016.

► [www.kampf.de](http://www.kampf.de)

## After two takeovers

■ Following the takeover of the two companies, Gala Industries and Reduction Engineering Scheer, in fall last year, Maag will be exhibiting the company's expanded product portfolio for the first time at the Chinaplas in Shanghai. Through the two takeovers, Maag has not only gained a broader geographic presence, but has also further expanded the product portfolio. The Swiss-based company has thus strengthened its position as global solution provider of machines for the polymer and compounding industry. With the new Pelletizer MAP6, a product will be on show for the first time on the fair stand at the Chinaplas that Maag and Gala are presenting together. The pelletizer is characterized by a user-friendly design: The knives are adjusted by means of a handwheel so that the operator can monitor the knife wear visually. The new valve that diverts the polymer stream between starting and pro-

duction position switches in less than one second and ensures stable start-up and shutdown processes. With the Pelletizer MAP6, customers benefit from Gala's many years of experience as pioneer in the field of underwater pelletization. A large number of the manufacturer's pelletizers are in operation in a very wide range of applications worldwide.

Centrifugal dryers are frequently used to dry the pellets after underwater pelletization. From this segment, the CENTRO 150 centrifugal dryer that is designed for a throughput of up to 22,000 kg/h will be on show on the fair stand. The CENTRO is particularly easy to clean and is characterized also by its high energy efficiency. By comparison with other dryers with similar drying capacity, it consumes up to 40% less energy. Both the rotor and the rotor screens are very easily accessible and are therefore easy to clean or



replace. On the fair stand the CENTRO will be on show together with the PWS25 Process Water Treatment System. The CENTRO was designed in Germany, and thanks to the local production in China can be offered with a good price/performance ratio. The proven BAOLI strand pelletizer will be presented on the fair stand in a new version, the 200 S. The BAOLI that is already successfully in operation with over 300 reference customers is suitable for the production of high-quality cylindrical pellets. Modern cutting tools guarantee high throughput rates – for example, up to 3,000 kg/h for PBT or PET compounds – and ensure a long availability of the strand pelletizer combined with low operating costs. The BAOLI is available in the three working widths 100 mm, 200 mm and 300 mm. The modifications in the design of BAOLI derive from a very close exchange of experience with BAOLI customers and offer improved handling and an optimized cost/benefit ratio. Maag's Powder Mill 25AC is designed for laboratory use in the preparation of samples in research & development. As an option, the powder mill can also be operated chilled and is suitable for a wide range of different branches: Plastics, rubber, adhesives, pharmaceuticals and foodstuffs. Thanks to its compact design, it requires a minimum of space in the laboratory. The 25AC is also characterized by its ease of operation and maintenance. One highlight of the fair stand will be the new Generation 6 of the extrex® extrusion pumps. Compared with the previous generation, they offer higher performance data despite their smaller dimensions.

*May be reproduced free of charge; please provide a copy of the published version (Photo: Maags Manually Adjustable Pelletizer (MAP))*

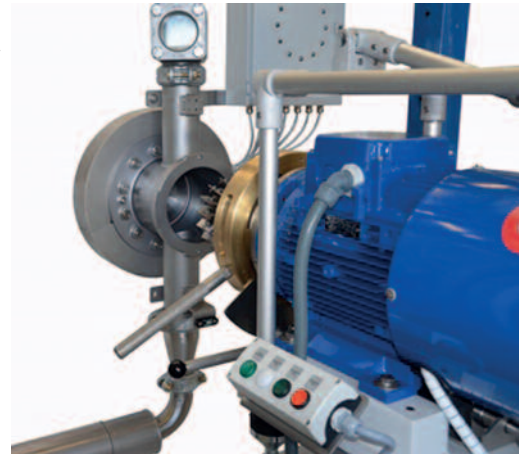

ons. The internal return flow has been significantly reduced, leading to a considerably higher volumetric efficiency. The gear pumps thus achieve an up to 50% higher throughput with comparable pump size. Alternatively a new extrex® Generation 6 can be operated at lower speeds while achieving the same throughput. This leads not only to lower temperatures and a longer service life of the pump, but also reduces the energy consumption by 10% or more.

► [www.maag.com/en/](http://www.maag.com/en/)



[www.kraussmaffeiberstorff.com](http://www.kraussmaffeiberstorff.com)

**Your benefits:**

- Powerful profile extrusion machines
- Cost-effective and tailor-made solution systems
- Space-saving coextrusion concepts

Chinaplas 2016,  
Area A10 between E1 and W1

**KraussMaffei Berstorff:**  
your partner for profile extrusion

Engineering Value

**KraussMaffei**  
Berstorff

## Third generation of KCC machines go into production

■ At this year's Chinaplas, which will be held in Shanghai from 25 to 28 April 2016, Kautex Maschinenbau will present a new model in its successful KCC series of extrusion blow molding machines. This is the third generation of the KCC series, which has been produced in Shunde, China, since 1997. The new blow molding machine model, which was announced at the Open House event in October last year, represents a complete relaunch of the KCC series. As well as a number of new and revised technical features, the machine has also been completely re-designed, to visually blend in with the look of new Kautex machines.

With its compact form, the new KCC generation takes up less floor space in the production hall. Better accessibility not only makes the blow molding machine easier to service, but also speeds change over times. Molds can now also be changed from the side, for example, and products are discharged from the rear of the machine. A greater standardization of modules and components has reduced the investment costs of the new machine and shortened future delivery times.

### New KSB suction blow molding machine

Kautex Maschinenbau will also allow first insights in its new KSB suction blow molding machine at Chinaplas. This brand new machine type was specially designed for low-flash production of 3D molded parts. Global demand for plastic ducts for the automotive sector is rising all the time, ever since the use of special materials such as PA6.6 or PPS has enabled the production of highly heat-resistant exhaust ducts. A modern operating concept with Kautex BC5 controller makes the new KSB machines easy to operate. In addition, the new suction blow molding machine takes up almost 50% less space than previous equipment, thus reducing investment costs.

► [www.kautex-group.com](http://www.kautex-group.com)

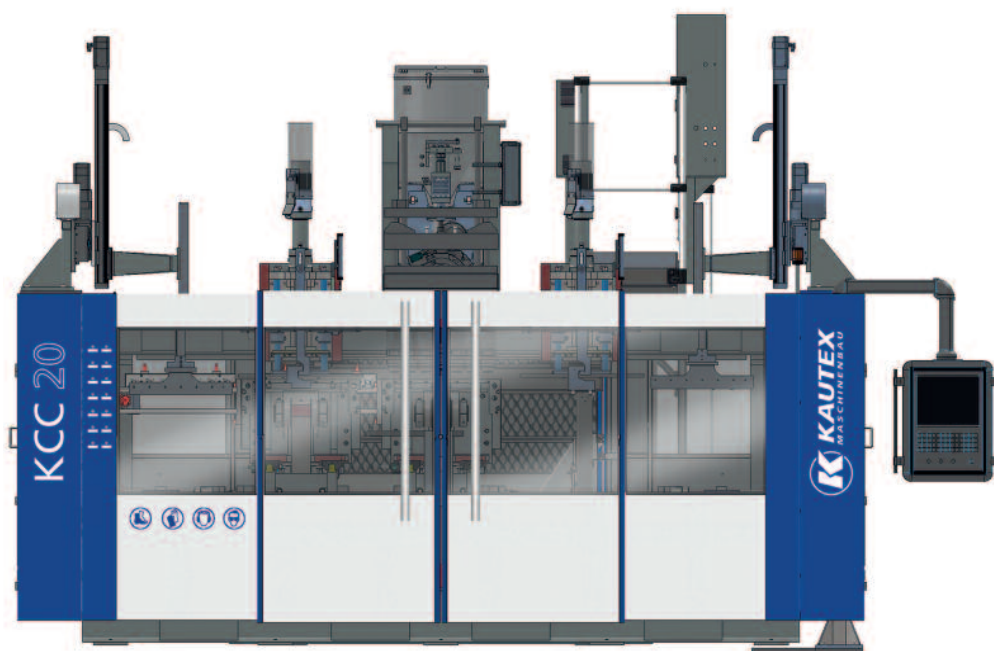

## Tailored LFT compounds the reliable way

■ ProTec Polymer Processing's focus at this year's Chinaplas from 25 – 28 April in Shanghai will be on the production of long-fibre-reinforced thermoplastics (LFT) by pultrusion and on the new generation of ProTec tumble reactors. These SSP (solid-state post-condensation) reactors are ideally suited to improving the properties of flowable plastics. Examples include the post-condensation of pelletised polyesters (PET, PBT, PEN etc.) and nylons such as PA6 and PA6.6. These "upgraded" materials are then for example converted into bottles, fibres and industrial yarns which are required for optical waveguides, tyre cords and for airbags, fibre-composite materials, filter fabrics or nonwovens. When injection moulded, LFT compounds with fibre reinforcement along the

length of the pellets result in components which combine high strength and light weight with very good surface quality. LFTs with a fibre length of around 12 mm are ideal for further processing.

### Flexible, versatile LFT technology

ProTec's LFT technology is suitable for producing a wide range of materials with differing levels of fibre reinforcement and many different polymer matrix materials which may also be directly compounded during LFT manufacture. Even the difficult pairing of carbon fibres with PP can be reliably processed. ProTec's headquarters in Bensheim (Germany) has a versatile cutting edge pultrusion line for application-specific customer testing and basic



*ProTec's LFT pultrusion technology produces high grade long-fibre-reinforced pellets with a wide range of polymer matrices and huge variety of reinforcing fibres. This technology also permits reliable and flexible adjustment of matrix properties (Photo: ProTec Polymer Processing)*

process and materials development. A keystone of the line is a high-performance compounding extruder equipped with a SOMOS® Gramix S gravimetric dosing system capable of accurately dosing and mixing up to nine components. As a result, a very wide range of individual formulations of the polymer matrix can be produced very flexibly directly in the process. Recycled material and additional fillers may likewise be included in the material formulation.

Producing LFT compounds by pultrusion involves continuously drawing fibre strands through a polymer melt, so impregnating the individual fibres with the polymer matrix and, once the resultant fibre/polymer strands have cooled, pelletizing them. In order to be impregnated, in the first process step, the fibre strands are guided from the creels by a specially designed guide into the impregnation die. Downstream from the die, the hot fibre/polymer strands are then finally shaped, for example into round strands or flat tapes, in a profiling system. After cooling in a cooling unit adapted to the polymer, they additionally pass through a puller which controls the continuous passage of the strands through the line.

ProTec is a one-stop shop capable of designing and supplying complete turn-key lines tailored to specific requirements from materials development to testing and commissioning on the customer's premises. The lines are capable of handling fibre contents of up to 60 wt.% and throughputs of up to 1,200 kg/h. Any conventional thermoplastics or even biopolymers such as PLA (polylactic acid) can be used as the matrix, while glass, steel or carbon fibres can be used as the reinforcing fibres.

The LFT line and all its modules are operated from the central line controller. Variable parameters include line speed, extruder throughput and pellet chopping length. Additional functions, located upstream or downstream depending on application, may also be incorporated into the control system. These include drying, conveying, dispensing and mixing of the feed components.

www.sp-protect.com



### MAAG – 4 STEPS AHEAD FOR YOUR SUCCESS

GEAR PUMPS, FILTRATION, PELLETIZING AND PULVERIZING SYSTEMS

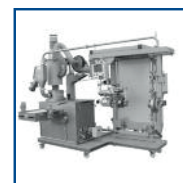
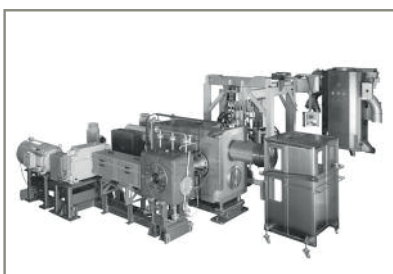

**Chinaplas** Come and see us at Chinaplas: Hall E1, Booth J21

maag pump & filtration systems

automatik scheer strand pelletizers

gala automatik underwater pelletizers

reduction pulverizing systems

www.maag.com

## 10 Years celebrated



First PVC-O pipes manufactured by Molecor®

■ It's been ten years since Molecor®, Spanish company that has become a leader in the development of molecular orientation technology applied to the conveyance of water under pressure was founded. Molecor® is present on five continents thanks to a revolutionary process that provides efficient and environmentally friendly systems to manufacture Oriented PVC pipes. During these ten years Molecor® has pushed limits beyond developing and improving an exclusive system that has revolutionized the water sector.

- 2006: Molecor® establishment
- 2007: PVC-O pipe DN200 mm and Air Based System
- 2008: PVC-O pipe DN 400 mm
- 2009: Spanish N mark for TOM® PVC-O pipes and French NF mark for TOM® PVC-O pipes made by Molecor®
- 2010: TOM® PVC-O: DN 500 mm and PN 25 bars certification
- 2011: TOM® PVC-O: DN 630 mm
- 2012: DN 600 (666,5 mm) and Integrated Seal System (ISS+)
- 2013: New factory, 11,000 T/year installed capacity
- 2014: DN 800 mm technology and 20,000 T/year installed capacity
- 2015: Molecor (SEA) Sdn Bhd (Malaysia) and PVC-O pipe up to DN 800 mm

The company has received several prizes during these ten years; in 2015 Molecor® was awarded as the best "Small and Medium Enterprise of the Year" in the second edition of the CEPYME Awards, highlighting its work both nationally and internationally and its role as an engine and pulse of the economy.

"We started our journey in 2006 and this gives us the title of favorite sons of the crisis. The change of environment, the uncertainty and the lack of financial resources, sharpened our in-

stinct to think different. And thinking different was not thinking like a micro-SME, which is what we really were, but thinking as an international company.

Developing an improper ambition of our size and trajectory, and clinging frantically to innovation as our only rescue.", said Ignacio Muñoz, Molecor CEO, collecting the CEPYME prize to the best SME of the year.

This year Molecor® will be present at various events worldwide, Smagua, Plastic Pipes and K 2016 among others, exposing its latest technology developments and TOM® pipes following its path divulgation of the outstanding features of PVC-O.

► [www.molecor.com](http://www.molecor.com)



## K 2016: Print@home saves time and money Online ticket shop open as of now

### Customised offers for travel and accommodation

■ Tickets for K 2016 from 19 to 26 October are available online at [www.k-online.com](http://www.k-online.com) as of now. The eTicket offers dual benefits, as it saves time and money. Visitors can purchase their tickets online, print them out on their own printers or download them as codes, and then travel free of charge to the trade fair by bus and rail. The eTicket is also much cheaper than tickets bought on site. The 1-day ticket thus costs EUR 49, while the price over the counter in Düsseldorf is EUR 65. The 3-day ticket can be had for EUR 108 online, and for EUR 135 over the counter. Anyone still looking for accommodation during K 2016 is well advised to make use of the services of Düsseldorf Marketing & Tourismus GmbH (DMT). This subsidiary of the city has the best overview of the hotels and private rooms available in Düsseldorf and environs during the world's No. 1 trade fair for the plastics and rubber industry and will help you make your booking. Incidentally, the pressure in the hotel sector has eased further. Within Düsseldorf's boundaries alone, some 1,000 new hotel beds have been created in the last few years, and in the neighbouring cities (e.g. Essen, Krefeld, Mönchengladbach and Wuppertal) these are joined by another 900 beds. In the Düsseldorf region, roughly 79,000 hotel beds are currently available. DMT has put together its entire package of services for K 2016 online, so a mouse-click is certainly worthwhile: <http://business.duesseldorf-tourismus.de/messe/K/>.

On top this comes an attractive offer from Messe Düsseldorf, Deutsche Bahn and DMT specifically for visitors to K 2016 from all over Germany: the price of the special return ticket (tied to specific trains and as long as stocks last) to Düsseldorf is:

- EUR 99, 2nd class
- EUR 159, 1st class.

This offer is available online for about three months before the fair opens.

K 2016 is open daily from 10.00 am to 6.30 pm. All admission tickets entitle the holder to free travel to and from the fair by bus, tram/metro and trains within the VRR and VRS integrated transport systems (2nd class, surcharge-free trains only). Further information on the transport network can be found at <http://www.vrr.de> and [www.vrs-info.de](http://www.vrs-info.de).

At K 2016, over 3,000 international exhibitors will be presenting their latest developments in the areas of machinery and equipment for the plastics and rubber industry, raw materials and auxiliaries, and semi-finished products, technical parts and reinforced plastics. Some 200,000 trade visitors from all over the world are expected at the trade fair.

➔ [www.k-online.com](http://www.k-online.com)

High precision dosing technology  
for broad application



**GDS** Twin Screw

### Gravimetric Dosing System

- Suitable for powders such as Caco3, talc, pigments and others
- No material bridges in weighted hopper and screw inlet
- No adherence of material at the screw surface
- Dust sealed
- Operator friendly design
- Siemens control

**Fdm**

A Piovan Company



[fdm.piovan.com](http://fdm.piovan.com)

## Surface treatment with maximum efficiency

■ Where surfaces of inorganic recipe components have to be homogeneously, completely and reproducibly coated with functional coatings in batch processes, high-performance universal mixers of the Uni tec® series from MTI Mischtechnik offer significant advantages over conventional systems. They produce, for example, a three-dimensional mixing vortex without any dead spots in which the entire material to be mixed is fluidised and the particles slide past each other in a fluid bed. The result

is maximum homogenisation with minimum time and energy consumption. At Powtech 2016, the company will present the Uni tec® high-performance universal mixer in Hall 1 on Stand 1-154 as part of its comprehensive portfolio of performance-optimised mixing and processing equipment.

All Uni tec® mixers are suitable for vacuum operation. This makes it possible to carry out complex processes such as vacuum drying after coating – which is necessary when using aqueous or alcoholic solutions – efficiently and inexpensively in one single machine. An optional chopper avoids formulation of lumps in the raw material. Spray systems for adding the fluids, double-jackets for tempering the vessels respectively electrically heated lids and surfaces plus a number of other options enable the adjustment to product-specific requirements. The operating parameters are permanently recorded and, if necessary, transmitted via bus systems for complete batch tracking.

In addition to the Uni tec® high-performance universal mixers, MTI Mischtechnik's product portfolio includes a wide variety of innovative mixer concepts for the plastics processing, chemical, food and pharmaceutical industries. This covers vertical high-speed mixers, horizontal universal and cooling mixers, various heating/cooling mixer combinations, a highly versatile laboratory mixer as well as the Vent tec® aspiration and filter system for optimum dryblend quality and maximum reduction of moisture content.

www.mti-mixer.de

Uni tec® UT 250 in MTI's R&D Center in Detmold/Germany  
Photo® MTI Mischtechnik



## Kiefel buys Mould & Matic

■ Kiefel GmbH, the German manufacturer of thermoforming machines, plans to buy all of Mould & Matic Solutions GmbH, an Austrian maker of injection molds, blow molding machines and tooling and downstream equipment for thermoforming, from Haidlmair Group.

Both companies have signed a purchase agreement, which still is subject to approval by government authorities.

Mould & Matic, in Micheldorf, Austria, is a supplier of molds and automation equipment for the packaging sector. In

2014, Haidlmair bought out the 50 percent share in Mould & Matic from its partner, Greiner Packaging International GmbH. The business had been operating as part of Haidlmair Group.

Kiefel, part of the Bruckner Group, is based in Freilassing, Germany. Haidlmair's headquarters is in Nussbach, Austria.

The companies announced the deal March 7. Terms were not disclosed.



Kiefel CEO Thomas Halletz said Mould & Matic complements Kiefel's range of products for packaging.

"This constitutes, together with the recent acquisition of Bosch Sprang, an important milestone in our efforts to offer customers the complete range of systems and services from a single source — from product development right up to downstream equipment," Halletz said in a news release.

Haidlmair Group is focusing more in its core business — large injection molds for products such as crates for beverage bottles, recycling bins and automotive parts.

CEO Mario Haidlmair said Mould & Matic will fit well with its new owner, a family business like Haidlmair.

Brückner Group, based in Siegsdorf, Germany, is a global maker of equipment and factory systems for the packaging and plastics industry. Besides Kiefel, its other units make film stretching machinery and services and other types of packaging machinery.

► [www.kiefel.com](http://www.kiefel.com)

## Windmüller & Hölscher shows newest innovations at Chinaplas 2016

■ German machine manufacturer Windmüller & Hölscher will again present its newest innovations for the production of flexible packaging at the Chinaplas 2016 (Hall E1, Booth J61) in Shanghai. W&H will provide information about its overall portfolio, which includes extrusion as well as printing and converting. As highlights this year the company names the modular blown film line AQUAREX with water cooling as well as the newly developed AQUACAGE. The AQUACAGE allows an automatic adjustment of the bubble diameter and thus increases the form flexibility of the line. „The demand for new, innovative films is increasing in all areas of application and industries. Our clients, especially in Asia, appreciate the high quality and the innovative properties of films produced with water cooling. With the development of the new AQUACAGE we continue to advance the line, always keeping the value added use for our customers in sight“, explains Michael Fischer, CEO Asia Pacific.

The AQUAREX blows film downward and uses water instead of air to cool the bubble. "The reason for this configuration is the rapid cooling of the melt", said Lennart Ederleh, Technical Sales Director Extrusion Equipment. He adds, "The extremely fast cooling keeps the crystallinity of the film low, maintaining its amorphous molecular structure. The resulting positive film properties are high clarity and gloss as well as good sealability, puncture resistance and favorable thermoforming properties". The newly introduced AQUACAGE can automatically adjust the bubble diameter for film widths between 750 und 1250 mm, similar to conventional blown film lines.

► [www.wuh-group.com](http://www.wuh-group.com)

## CONEXTRU ENGINEERING FOR EXTRUSION

**You need a new tool for your new pipe product?**

- quick and at low cost – specially made for your request
- in mono- or multi-layer or for coating in your current pipe production

You want to modify your existing tools to multilayer and for internal pipe cooling, to make a new product?

Then **CONEXTRU GmbH** is the partner for you – the most experienced company in pipe tool design.

**The development of new tools for pipes is our profession and passion – for more than 25 years.**

## AMUT for corrugated PVC sheet complete extrusion line

■ The corrugated PVC liner panels allow efficient roofing and cladding of several structures, thus representing an optimal solution for outdoor applications. Actually, the panels have a surface easy to clean/sanitize and an excellent resistance to chemicals as well as to marking and scratching. Further, the PVC is non-flammable, rustproof and easy to maintain. The corrugated PVC sheet produced with AMUT lines can have different geometries and a thickness range from 0.8 up to 2.0 mm. The extruders are twinscrew type, series BA. These extruders are suitable to work with special raw materials and additives giving UV and weather conditions resistance properties to the sheet. A horizontal flat die, a calibrating system, a haul-off unit equipped with 3 pairs of rolls and a cutting unit, guillotine type, compose the downstream of the line.



► [www.amut.it](http://www.amut.it)

## Coperion Corporation relocates to new premises

■ Coperion GmbH, a subsidiary of Hillenbrand, Inc. (NYSE: HI), has successfully realigned and relocated their North American operations from Ramsey, New Jersey, to their other facilities located in Pitman, New Jersey, Wytheville, Virginia and Houston, Texas. This realignment was implemented over an 18 month period of time from June 2014 until November 2015. Personnel moves have been completed and staff has moved to their new locations. The facilities in Pitman and Wytheville have gone through alterations and have increased space to accommodate the additional functions transferred to each location. The Wytheville plant has added an additional 52,000 sq.ft. in order to accommodate the new manufacturing, assembly functions, and warehouse department. The Pitman location has undergone an extensive reconstruction and now houses Coperion's U.S. extrusion test lab, process technology,

engineering, sales, customer service, and support functions in addition to the already existing Coperion K-Tron feeding technology business.

Coperion customers should expect order processing, equipment inspections and demonstrations, and extruder testing to be scheduled through the facility in Pitman, New Jersey. The facilities in Wytheville, Virginia, are used for manufacturing purposes including machine and gearbox refurbishing, assembly, factory acceptance tests and shipping, while Coperion's Houston, Texas office continues to support sales, service and engineering.



► [www.coperion.com](http://www.coperion.com)



## First Bubble Guard® Board line hitting USA market

### ■ Primex Plastics Corporation's new line goes on stream

Primex Plastics Corporation based Richmond (Indiana, USA) and founded in 1965, is the leader in custom extruded plastic sheet and roll products for thermoforming, fabrication and printing. With facilities in five States from coast to coast and in Great Britain, Primex Plastics Corporation is one of the largest plastic sheet producers in the US. A state-of-the-art full optional BUBBLE GUARD® BOARD line by COLINES® has been successfully installed and commissioned at Primex Plastics headquarters in Richmond, producing sheets for printing and packaging applications.

Thanks to the perfect cooperation between the technical teams of COLINES® and Primex Plastics, the line started successfully in February 2016 producing Bubble Guard® Board sheets with a great flexibility allowing "on the fly" width change from 1220 mm (48") up to 1600 mm (63").

COLINES® group structure, unique in the industry, allowed a training program of Primex Plastics team at its sister company Imballaggi Protettivi in Italy during the manufacturing period: this



granted a smooth startup of the line at Primex Plastics premises. Michael J. Cramer, Primex Plastics Corporation's President said: "We were very pleased with the whole experience, COLINES professionalism, expertise and interaction between the Groups. The level of preparation required for a project of this magnitude resulted in no major issues throughout the process and this allowed an early successful commissioning".

► [www.colines.it](http://www.colines.it)

**VII INTERNATIONAL SPECIALIZED EXHIBITION «ROSPLAST»**

**2016  
June  
15-17**

**CROCUS EXPO**  
International Exhibition Center



**ROSPLAST**  
PLASTICS, EQUIPMENT & ITEMS

**WE INVITE YOU TO PARTICIPATE!  
RUSSIA, MOSCOW**

**[www.rosplast-expo.com](http://www.rosplast-expo.com)**

**Exhibition organizer:**

**+7 (495) 330-0847**

**+7 (495) 330-0483**

**[info@rosplast-expo.ru](mailto:info@rosplast-expo.ru)**

# ZE BluePower twin-screw extruders attract great interest from customers

*On the occasion of the TecDay on 24 February 2016 in Hannover, KraussMaffei Berstorff exhibited their latest twin-screw extruder development – the ZE 65 BluePower Torque. Being designed for challenging requirements in high-performance compounding, this new machine generation is the ideal solution for customers who expect to achieve unparalleled quality and high performance combined with substantial energy savings.*

*Ralf J. Dahl - Head of the Twin-Screw Extruder Division at KraussMaffei Berstorff - presented the innovative technical features of the ZE BluePower twin-screw extruder series*



## Demonstration of maximum performance

“The live demonstration on the TecDay furnished ample proof of the increase in productivity, performance and energy efficiency achieved with the ZE BluePower twin-screw extruder series,” reports Ralf J. Dahl, Head of the Twin-Screw Extruder Division at KraussMaffei Berstorff. The new ZE 65 BluePower Torque was used to process polyamide 6 with a 30 percent glass fiber content at a maximum output rate of 2,500 kg/h, about 90 percent torque and a screw speed of 1,200 revolutions per minute. “Such a performance level is simply unique for this machine size,” adds Ralf J. Dahl highly satisfied.

## Informative lecture program

The live demonstration was preceded by an extensive lecture program. The opening lecture about the utilization of energy saving potentials in compounding held by Robert Schmitt, CEO of SKZ-Cert GmbH, provided general information on legal aspects and standardization in the field of energy management systems and hands-on recommendations for sustained savings during production. The second lecture about user demands on compounding lines by Oliver Borgelt, plant manager of Zülpich-based Albis Plastic GmbH, also attracted great interest. Oliver Borgelt outlined the energy efficiency increase achieved in compounding and the expectations of compounding companies as far as the machinery is concerned. The lecture of Thorsten Schroer, Assistant Head of Plant Engineering at KraussMaffei Berstorff, focused on KraussMaffei Berstorff’s compounding plant engineering know-how. During the demonstration of the ZE BluePower extruders, definitely the highlight of the TecDay, Ralf J. Dahl returned to the previously mentioned requirements and showed how they were implemented in the new series. “In



The TecDay participants were fascinated by the unique performance of the ZE 65 BluePower Torque twin-screw extruder used for processing polyamide 6 with a 30 percent glass fiber content at a maximum output rate of 2,500 kg/h

point optimization of the drive system, including water-cooled three-phase motor and high-efficiency gear unit, with a completely redesigned processing section. As compared to the previous ZE A UTX series, the ZE BluePower features an increased OD/ID diameter ratio of 1.65, which gives a 30% higher torque density of up to 16 Nm/cm<sup>3</sup>.

**Innovative technology secures competitive edge**

For national and international compounding companies that plan investments in extrusion technology, the TecDay offered an ideal opportunity to take a closer look at the ZE BluePower series and the appropriate upstream and downstream equipment. The KraussMaffei Berstorff extrusion line was complemented by supplies from Brabender Technologie GmbH & Co. KG (loss-in-weight feeder), Cabot Switzerland GmbH (masterbatch), DSM N.V. (polyamide 6), EMDE Industrie-Technik (bulk material handling), Gala Kunststoff- und Kautschukmaschinen GmbH (underwater pelletizer), NERAK GmbH Fördertechnik (elevator conveyor), PPG Industries Fiber Glass B.V. (glass fibers) and Simar GmbH (bulk material handling).

addition to numerous technical innovations, the overall concept convinces by unparalleled performance, high cost-effectiveness and increased energy efficiency," says Ralf J. Dahl.

**Increased free volume and enhanced torque density**

The new ZE BluePower twin-screw extruder series is characterized by numerous innovative features in terms of energy efficiency and process engineering. This series combines operating

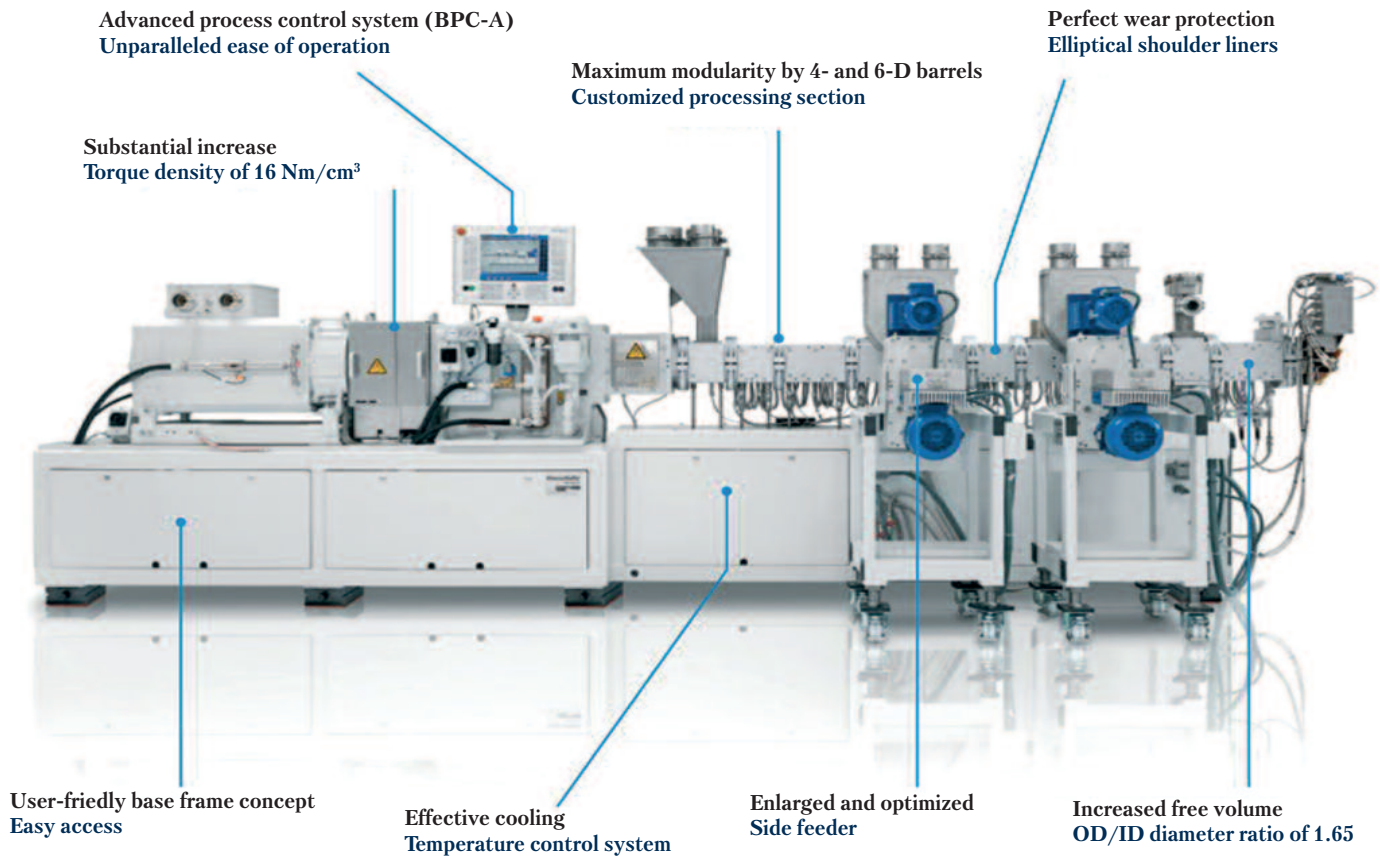

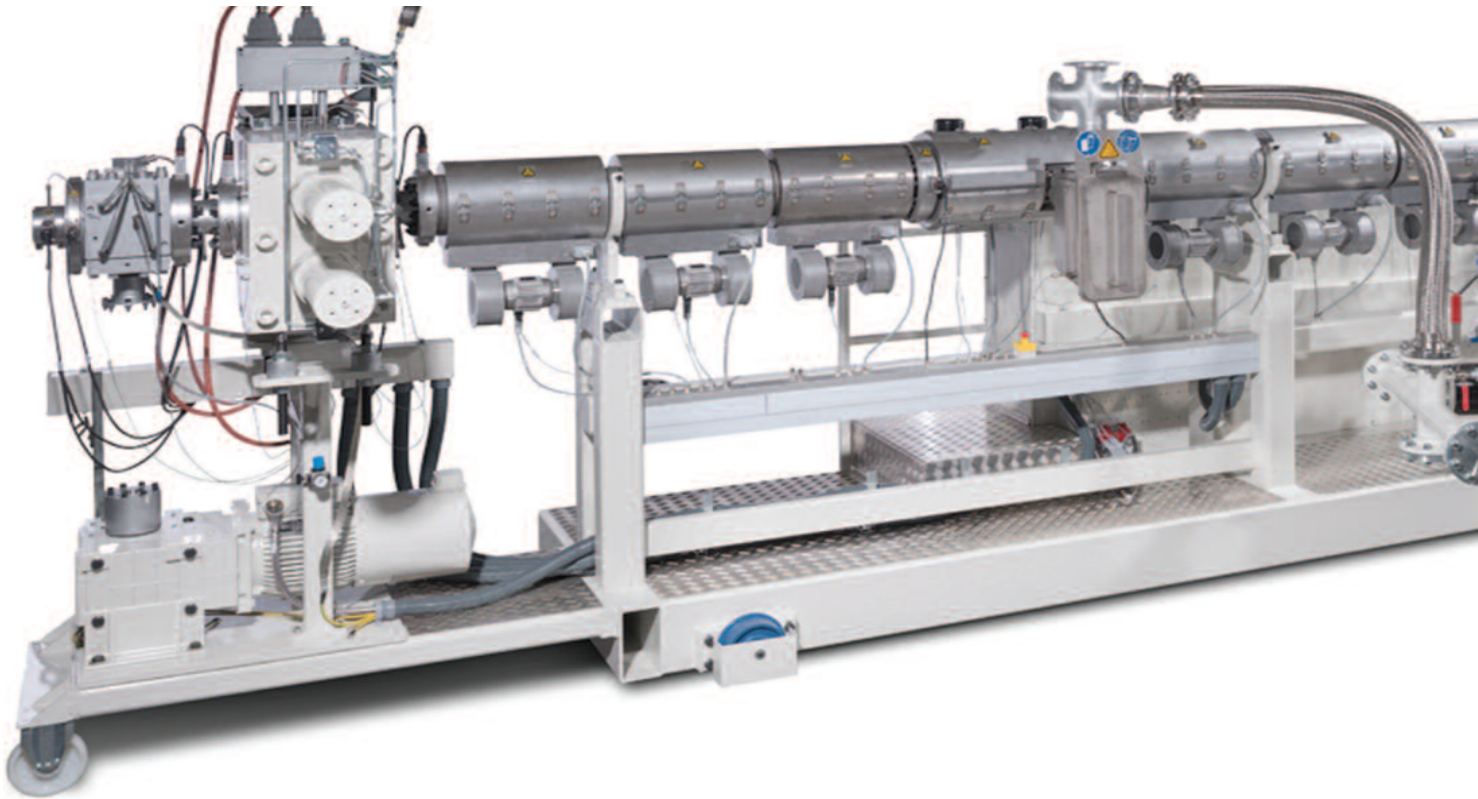

# Material and energy saving in thermoforming sheet, pipe and profile extrusion

The company battenfeld-cincinnati have been presented at Plastimagen 2016 efficient extrusion solutions for a wide range of applications. The focus will be on high-speed extruders, STARextruders and the Multi-Touch roll stack for thermoforming sheet extrusion. The port-folio of single and twin screw extruders, pipe heads and downstream equipment for pipe and profile production will also be featured.

## Optimal solutions for thermoforming sheet extrusion

battenfeld-cincinnati's high-speed extruders are 75 mm single screw extruders with a length of 34 L/D and are suited for processing PP, PS, APET, CPET, PLA, PE and PC. Over the last decade, more than 250 units have been installed worldwide. The extruders have optimal melt attributes and outputs range

up to 1,800 kg/h. In addition, they consume up to 25% less energy compared to conventional extruders with the same output rates.

A variety of roll stacks is available from battenfeld-cincinnati, of which the newest is the Multi-Touch roll stack. A unique roll configuration ensures consistent, uniform cooling on both sides of the sheet, even at highest line speeds. This results in stress-free sheet with optimal transparency, excellent flatness and a uniform thickness profile, as well as significantly improved sheet tolerances. Thanks to this, material savings of 2-4% are possible.

For direct extrusion of PET, the STARextruder series is gaining recognition in the market. With the combination of a single screw and planetary section, it offers the advantage of easy

*STARextruder: ideal for direct processing of PET*

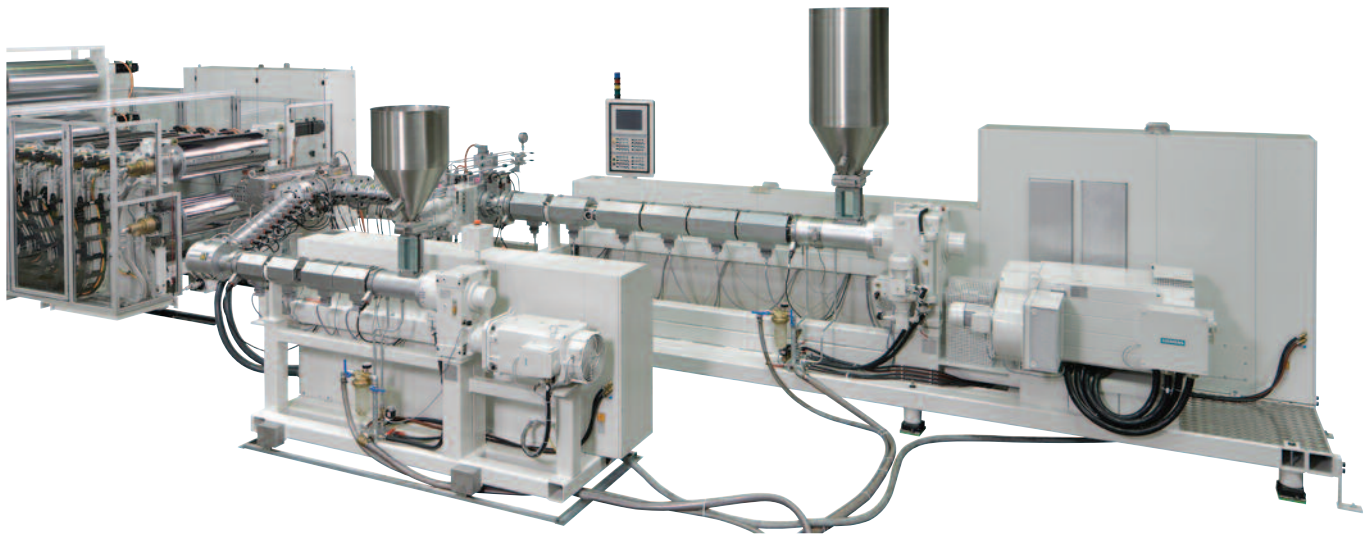

*High-speed extruder and Multi-Touch roll stack combination for thermoforming sheet extrusion*

handling and highly efficient degassing of the melt. The available machine sizes of 90, 120 and 150 mm are perfectly suited for small and medium out-put ranges. Thanks to the elimination of pre-drying, the STARextruder helps save energy in the production process.

**Complete, energy-efficient extrusion lines for pipe and profile**  
 battenfeld-cincinnati offers complete lines from a single

source, from extruder to pipe heads and modular downstream equipment. Solutions for special applications such as multi-layer pipe and profile co-extrusion are also available. As a technology leader in the field, battenfeld-cincinnati offers tailor-made, large-diameter pipe extrusion lines for PO pipe up to 2.6 m and PVC pipe up to 1.6 m.

► [www.battenfeld-cincinnati.com](http://www.battenfeld-cincinnati.com)

# New Technology for Breathable Products

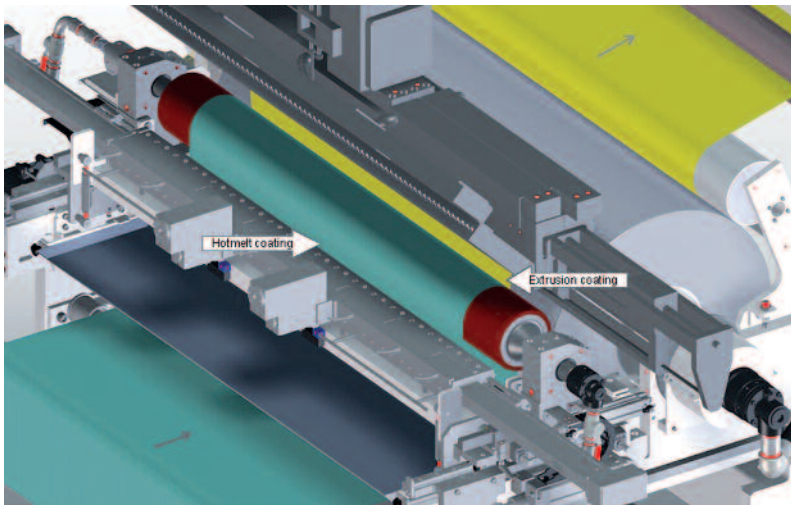

*SML has developed and installed a new laminating line that is capable of downgauging the coating layer to a previously unobtainable extent using the so-called "DoubleCoat" process.*

*"DoubleCoat", for which a patent is pending, has been integrated into the proven FlexPack extrusion coating line thereby enlarging considerably the attainable range of breathable products.*

"DoubleCoat" combines extrusion coating with hot melt lamination and thus facilitates coating thickness minimisation.

For example, a minimum coating layer thickness of 7 µm can be achieved using TPE on a PP nonwoven. This corresponds with roughly a mere quarter of the current average for such coatings and results in enormous material savings.

Excellent product quality is guaranteed and even with thin coating layers adhesion to the substrate is perfect and no pinholes occur.

Another exciting feature of the process is enhanced product breathability. The coating thickness has a significant effect on the water vapour transmission rate (WVTR), as a thinner layer results in a reduction in water vapour flow resistance.

Consequently, standard product breathability can be increased several times over.

A further advantage offered by the new process is a reduction in the melt temperature to a minimum. This has a very positive effect on the mechanical characteristics of the coating because the material is subject to less stress during extrusion.

The advantages of the "DoubleCoat" process at a glance:

- Reduced coating layer thickness
- Material savings and hence lower costs

- Strong adhesion
- Improved breathability
- High water column
- Enhanced mechanical properties

The "DoubleCoat" process provides fresh possibilities for enhanced product properties and lower production costs with regard to a variety of applications.

These include medical products such as surgical drapes, which are highly breathable, flexible and serve as an effective barrier against viruses and bacteria. The process could also be used for protective clothing such as disposal overalls, or in view of its soft touch, stretchability and high breathability, for hygiene products. Moreover traditional construction industry products such as roofing underlay can benefit to an equal extent from this new method.

Interested customers will soon be able to see the outstanding performance of SML's FlexPack extrusion coating line with the "DoubleCoat" process for themselves, as a production scale pilot plant will be available for trials from April 2016.

**Dear reader,**

**Now you have an opportunity**

**to get immediate notifications when new issues  
of Extrusion International are published:**

- 1. Just click the red button down there**
- 2. leave your e-mail address to start getting the announcements**



## **Learn more about...**

**Extrusion of film**

**Extrusion of pipe, profile, and sheet**

**Raw materials. The specificity of the extrusion  
of PVC, PP, PE, PET**

**Masterbatch & additives**

**Compounding & mixing**

**Recycling**

**Die, screw, filtration, granulator, and melt pump**

**Automatic, control**

**Peripherals**

**Converting, printing, and lamination**



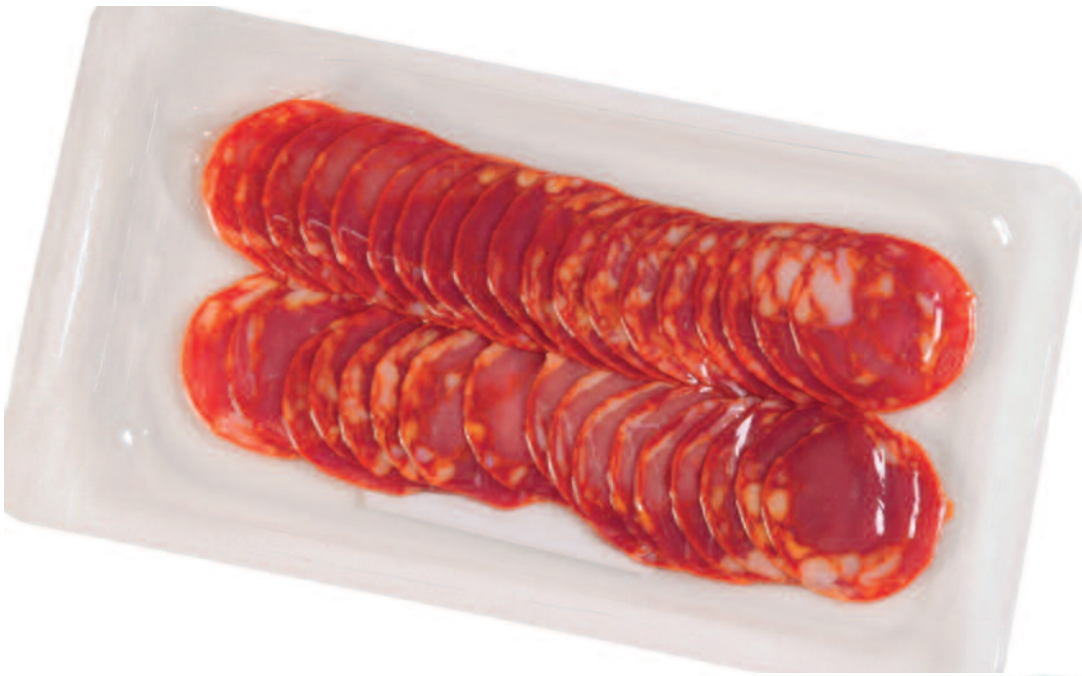

*A coextrusion die system from Nordson Corporation has enabled an extrusion processor specializing in PET-based semi-rigid packaging sheet to maintain layer uniformity well within tolerances while avoiding product defects arising from asymmetrical layer structures.*



# Flow control and versatility of coextrusion

**E**vertis de México S.A. de C.V., a manufacturer of thermoformable sheet for food packaging such as poultry, cheese, and processed meat, as well as non-food applications, recently installed a Nordson EDI coextrusion die system for producing a range of structures. These include standard multi-layer, medium-barrier, and high-barrier sheet with thicknesses from 180 to 1,016  $\mu$  (0.180 to 1.016 mm). The barrier sheet structures are

often asymmetrical, in that the materials or layer thicknesses above the central layer differ from those below it. The precision flow control of the Nordson EDI system has made it possible to maintain tight layer tolerances in such structures while preventing "wave," "zig-zag" and other defects caused by instabilities at the interface between layers.

"At Evertis we strive to improve our production methods and



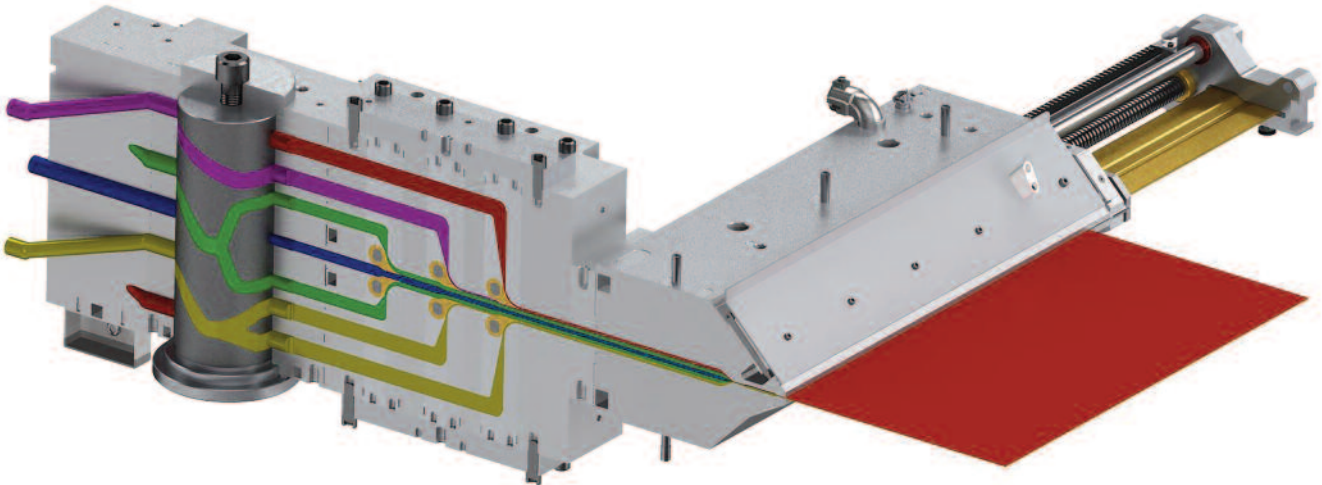

consistently supply high quality products," said Aprigio Pinto, director of production at Evertis de México. "We work with avant-garde equipment suppliers whom we know we can count on for excellent customer service and assistance. This philosophy is crucial to Evertis de México, given our continuous growth in the markets we serve."

"The immediate responses by the technical support team at Nordson means that Evertis de México is guaranteed high quality equipment and service at a competitive price in the market," said Jacques Tillet, director of maintenance at Evertis de México. "At Evertis we produce semi-rigid barrier PET sheet for food and non-food applications, and it is essential that we maintain layer uniformity within tolerances at all times. The Nordson EDI die system allows us to control layer interfaces, and thereby avoid product defects such as waves. With this system in place we feel confident that our customers will receive high-quality products every time."

#### Meeting the Challenges Posed by Asymmetrical Multi-Layer Structures

"Because critical layer interfaces are shifted into higher shear regions of the flow paths, coextrusion instabilities are more common with structures that are asymmetrical," said Nordson EDI chief technologist Sam G. Juliano. "Our die system yields streamlined melt streams and fine-tunes them at the point of confluence. In addition, the ease with which adjustments can be made enables the system to be quite versatile in both layer configuration and product width."

Chief among the components of the Nordson EDI die system used by Evertis de México are the following:

Ultraflex™ die with Multiflow™ II-G manifold and internal deckle. Nordson has engineered the manifold, or flow channel, inside the die to reduce shear stress levels at the layer interfaces, resulting in improved layer uniformity. At the same time, the sections of the manifold at each end of the die are sized to accommodate adjustable internal deckles for making changes to product width.

Ultraflow™ V-S adjustable feedblock. A feedblock combines melt streams from separate extruders into a multi-layer "sandwich" that the extrusion die subsequently distributes to target product width. The Ultraflow V-S feedblock incorporates adjustable "combining planes" located where the melt streams join the central flow channel. These make it possible to balance the velocities of the combining streams. When operating in "free-float" mode, they automatically compensate for the changes in layer thickness ratios that accompany product structure changes. Adjustments can be made without taking the feedblock off-line, increasing up-time and end-product versatility. Another adjustment that can be carried out on-line is use of a selector spool that makes it possible to change layer sequences in the structure.

Evertis de México S.A. de C.V. is a subsidiary of the international IMG Group, a pioneer in the field of PET film extrusion. In addition to the plant in Mexico, the group has manufacturing facilities in Brazil and Portugal and sales offices throughout the Americas and Europe. Evertis de México is located at Ave. Platón No. 138, 66600 Cd Apodaca, N.L., Mexico.

Tel: +52-81-8386-5550.

Fax: +52-81-8386-5553.

Visit: <http://www.evertis.com/es/home>.

Photo Caption: Cut-away schematic of Nordson EDI die system supplied to Evertis de México shows Ultraflow™ V-S feedblock at left and Ultraflex™ die at right, with internal deckle (bronze-colored component) projecting from the die. The seven-layer film structure is asymmetrical, with different materials above and below the central layer. The cylindrical component in the feedblock is a selector spool for on-line changes to layer sequence. The six yellow teardrop-shaped components at points where layers converge are combining planes for fine-tuning of combination velocities.

# Versatile plant engineering for high quality LFT compounds

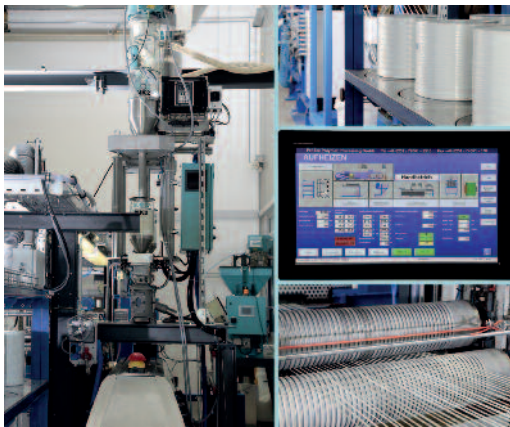

*LFT pultrusion plant at ProTec's Bensheim technology centre – designed for developing high-quality long-fibre-reinforced compounds with many and varied polymer matrices and reinforcement fibres (photo: ProTec Polymer Processing)*

With the acquisition of PolymersNet GmbH, Lampertheim, in late June this year, ProTec Polymer Processing also took possession of the pultrusion plant installed there for producing long-fibre-reinforced thermoplastics (LFT). The plant has now been rebuilt and extended at ProTec's Bensheim process and materials development technology centre where it can also be used for carrying out specific customer tests. A new, central component of the plant is a high-performance compounding extruder and the plant controller has also been designed for automated operation of all process steps. With these new facilities, the LFT plant has restarted operation with trials commissioned by clients; further development activities are already in the pipeline. When injection moulded, LFT compounds with glass, steel or carbon fibre reinforcement along the length of the pellets result in high-strength, lightweight components which simultaneously have very good surface quality. Any conventional thermoplastics or even biopolymers such as PLA (polylactic acid) can be used as the matrix. "With focused know-how along the entire LFT process chain, ProTec has established an efficient structure for this high-performance technology. We are now a one-stop shop for our current and future clients, offering everything from materials development to testing and commissioning of a tailor-made LFT pultrusion plant. We design plants for fibre contents of up to 60 wt.% and throughputs of up to 1,200 kg/h, and all at a fair market price", explains Managing Director Peter Theobald.

The new compounding extruder installed in the LFT develop-

ment plant at Bensheim with its co-rotating, 26 mm diameter twin screws is designed for throughputs of up to 150 kg/h. Installed upstream of the extruder is a SOMOS® Gramix S gravimetric dosing system for accurately dosing and mixing of up to nine components. As a result, a very wide range of individual formulations of the polymer matrix can be produced very flexibly directly in the process. Recycled material and additional fillers may likewise be included in the material formulation. The LFT plant's impregnation die, where the fibre strands are spread apart and enveloped with polymer melt, is designed in such a way that, even at recycled material contents of up to 10% in the melt, consistently high quality impregnation of the fibre filaments is achieved. The various different creels required for unwinding glass and carbon fibres in the pultrusion plant are also available.

## LFT compounds - produced by pultrusion

LFT compounds are produced by pultrusion which involves continuously drawing fibre strands through a polymer melt, so impregnating the individual fibres with the polymer matrix and, once the resultant fibre/polymer strands have cooled, pelletising them. LFT pellets for injection moulding are conventionally around 10 to 12 mm in length. Pellets 25 mm in length (LFT compounds with extra-long fibres) are used for compression mouldings. In the first impregnation process step, the fibre strands are guided from the creels by a specially designed guide into the impregnation die.

Downstream from the die, the hot fibre/polymer strands are then finally shaped, for example into round strands or flat tapes, in a profiling system. After cooling in a cooling unit appropriate for the polymer, they pass through a puller before finally being finished. It is the puller which controls continuous operation of the plant, the tensile force it applies to the fibre strands extending right through the impregnation die to the point at which the strands are unwound from the individual fibre bobbins. The LFT plant and all its modules are operated from the central plant controller. Controlled variables include line speed, extruder throughput, pellet chopping length and, if required for the particular application, other up- and downstream functions of the overall plant.

► [www.sp-protec.com](http://www.sp-protec.com)

*Stagnation is a foreign word to the 200 SIKORA employees worldwide. Regarding this background, a new product of groundbreaking innovation was created, the CENTERWAVE 6000. The core: Several transceivers, arranged around the circumference of a tube, sending and receiving continuous frequency modulated millimeter waves for a non-contact and  $\mu\text{m}$ -precise online measurement of diameter, ovality and wall thickness for larger plastic tubes during the extrusion.*

*CENTERWAVE 6000: Key technology for quality assurance during the extrusion of big tubes*

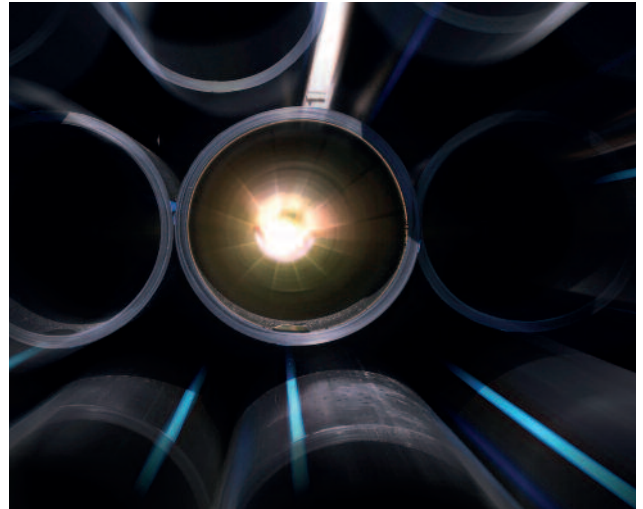

# Quality assurance during the extrusion of big tubes

During the last years, enormous successes regarding measuring accuracy were achieved by researching metrological applications with frequencies in the millimeter waves range. Nevertheless, the results could not yet be used for the coating thickness measurement of cylindrical products. With the novel, innovative measuring system, the CENTERWAVE 6000, SIKORA creates completely new preconditions for the reliable measurement of the nominal size as well as the outer diameter, ovality and wall thickness of all kinds of extruded DIN-tubes.

## Advantages of the new millimeter waves technology

Even without any knowledge of the properties of the extruded materials and its temperatures, the CENTERWAVE 6000 measures the outer contour as well as the wall thicknesses simultaneously at several places of the circumference, providing a precision to a previously unknown degree. Layer thicknesses of multi-layer tubes can also be measured precisely. Several sensors, so-called transceivers, arranged around the circumference of a tube, continuously send and receive frequency modulated millimeter waves. Boundary layers, as for example each front and back site of a plastic, reflect these waves, which are detected and demodulated by the receive unit of the regarding transceiver. These receive signals contain information regarding the distance between boundary layers of different materials. After an algorithmic processing of the receive signals of each sensor, the requested measuring values are ready for visualization within only a few milliseconds. The values can as well be used for the control of the different dimensions of a tube in the extrusion line.

## Replacement of conventional technologies

For the development of the technology on the basis of a CW-millimeter wave chip, the goal of creating a non-contact measuring device at the extrusion of tubes that is maintenance-free and durable, was decisive. By independently identifying the characteristic values of the material, the CENTERWAVE 6000 generates the measuring values with highest precision, without the need for specifications regarding the material parameters. The CENTERWAVE 6000 is going to provide highly precise measuring values at different positions of the production line (even in the hot area) as there are no coupling mediums needed, temperatures are not decisive and no calibrations are necessary.

## Product Spectrum

Two stand-alone gauge heads for different tube diameters from 120 to 400 mm and 250 to 1.000 mm were created. The industrial PC ECOCONTROL 6000 offers, besides a numeric presentation of the measuring values, also a graphic visualization as well as extensive trend and statistic data features. The calculation of virtual measuring values at the position of the extruder allows the line manager to react quickly to changes. Even with larger delay times between the position of extrusion and the measurement an effective and fast control of the wall thickness and especially the elimination of excessive consumed material is guaranteed.

# motan-colortronic shows the latest developments in the medical area during MEDTEC

*motan-colortronic gmbh, Friedrichsdorf, Germany, a producer of systems for sustainable raw materials handling in the areas of injection moulding, blow moulding, extrusion, compounding and in the chemicals industry, will show the latest developments of the pharmaceutical and medical area during MEDTEC EUROPE, Stuttgart, Germany, 12th to 14th April 2016.*



METRO G loader range

## LUXOR CA S

Injection moulders producing very small parts are faced with the unique challenge of being able to dry just the right amount of material for their process. Operating in extremely critical production conditions, these smaller throughputs can present considerable problems. Consequently, it is important to scale the drying to the size of the moulding machine. The new LUXOR CA S range of dryers fits perfectly into this concept. It is also suited for cleanroom applications.

The LUXOR CA S range with hopper volumes of 0.75 / 1.5 / 3 and 5 litres has been conceived especially for the production of small and micro parts. The range is comprised of a modular line of correctly sized drying equipment helping moulders to meet the small tolerances without waste or contamination. On account of their light and compact construction, the dryers can be simply mounted on all processing machines, also when space is highly restricted. The LUXOR CA S compressed air dryers take factory supplied compressed air which is expanded to atmospheric pressure. This produces dry process air – with a very low dew point – which is then heated to the required drying temperature. No desiccant is necessary making the dryer perfect for clean room conditions. All models are equipped with a thermostat and low air flow safety switch to prevent overheating of the material in the event of insufficient air throughput.

Due to the wide temperature range (30 - 180°C) the LUXOR CA S micro dryers can be used for many different materials. A pre-filter cleans the compressed air. This



**LUXOR CA S**

feature prevents contamination of high-quality materials and provides optimum drying conditions. The complete drying bin body is made from a single piece of special glass – ideal for contamination critical process applications.

An additional benefit of the all glass construction is its transparency. The operator can always see the actual status of material in the bin. Constant and stable conditions in the entire drying hopper are an essential prerequisite. Therefore, the complete drying hopper right down to the material discharge is heat insulated because of a double glass wall construction. This design is an important energy saving advantage. The expertly designed air diffuser provides uniform distribution of the dry air ensuring that the material – even at the material bin outlet – is kept at a constant temperature and in the required dry condition.

**METRO G**

motan-colortronic's spotlight this year will be focused on its innovative METRO G range of material loaders. This development by motan engineers combines the latest technologies from colortronic and motan and also enhances those systems with a number of new features. METRO G's modular building block system allows users to configure and create the optimal material loader for any application. For example, a standard material loader unit can be expanded into a clean room version just by adding special vacuum diaphragm valve. A dust removal module provides for fine dust removal at the material loader, essential for some critical engineering plastics where absolutely no dust is allowed to enter the process. The system can also be fitted with modules with a tangential material inlet to provide a cyclone effect for processing those materials where a more coarse dust separation is required. METRO G allows users to configure the right material loader for their specific application.

**ULTRABLEND**

ULTRABLEND offers clear advantages to manufacturers of thermoplastic medical devices. The processing of raw material com-

pounds that are sometimes extremely expensive in hygienically clean operations into medical primary packaging, components, implants, instruments and equipment requires the highest levels of cleanliness, precision and cost discipline.

The gravimetric ULTRABLEND blender has been developed for consistently precise dosing and mixing of free-flowing raw materials – plastic granulates and additives. It improves process quality and stability and makes its own contribution towards minimising production costs. With the design in electro-polished stainless steel, motan has placed great emphasis on clear functions, minimum maintenance and easy operation in a hygienically clean production environment. All material hoppers and mixing chambers have been designed without any “dead



*Membran valve for clean room applications*

zones”. All seams are fully welded. As a result, no residual amounts of material can build up and contamination of subsequent batches is therefore eliminated.

The ULTRABLEND is especially suitable for precise dosing of extremely small amounts of material directly into the injection moulding, extrusion or blow moulding machine. A maximum of four raw material

**ULTRABLEND**



components can be dosed by weight, one after the other, precisely as required by the recipe. They are then mixed together homogeneously in the downstream mixing chamber (4.5 litres volume) and fed into the feed throat of the processing machine. The minimum dosing amount is 3 g per component (900 g lot size).

When two components are used a maximum throughput of 260 kg/h can be achieved.

Medtec Europe Hall 7, Stand 7C16

[www.motan-colortronic.de](http://www.motan-colortronic.de)

# Intelligent Communication



*Selection of gauges with Profibus/Profinet interface*

In industrial production, numerous automation, engineering and visualisation systems are connected to a bus. The PROFIBUS interface enables centralised control of all devices involved in the production process as well as many standard diagnostic functions – and all this via a secure and fast connection. The cyclic collection and preparation and reliable evaluation of the measuring data via the interface has a significant effect on the quality of the quality monitoring. ZUMBACH's communication via PROFIBUS DP not only significantly improves the workflow between individual production units. It also requires little hardware (one engineering tool for all devices), thus reducing investment and service costs. Thanks to the bus topology, sensors can be coupled and uncoupled during operation.

Practically every ZUMBACH device is available for use in PROFIBUS DP structures, directly or via a PROFIBUS interface. Through the use of an intelligent ZUMBACH protocol, the complete functionality of each ZUMBACH sensor is fully supported from the initialisation step all the way to the actual data exchange.

PROFINET IO – the successor to PROFIBUS DP – is designed for data exchange between Ethernet-based field devices.

The open Industrial Ethernet standard meets the increasing demands of automation reliably and sustainably with optimum flexibility, efficiency and performance.

► [www.zumbach.com](http://www.zumbach.com)



# Thermoforming Line for Drinking Cups with IC-RDM 70K

At Chinaplas, Shanghai, hall E1, stand A45, ILLIG will present a fully automated, state-of-the-art production line for drinking cups, completely from one source, April 25 to 28. In this thermoforming system where the individual machines are optimally synchronized the IC-RDM 70K automatic roll-fed machine serves as forming machine. Drinking cups, diameter 89.5 mm, are manufactured on this machine with a 14-up mold out of APET, forming area 680 mm x 300 mm. Current machines are equipped with the IC operating concept (ILLIG Intelligent Control Concept), so the high productivity of these servo driven thermoformers can be utilized easily, reliably and fast to the full extent. The trade fair machine is combined with the new, also servo driven SZA 73c stacking machine.

Thanks to its modular design the stacking machine can be equipped with different discharge options. Automatic feed to downstream machines can also be realized with the new SZA 73c, here to a rimming machine to automatically form the lip roll of the drinking cups.

Machines of the RDM-K series are specifically designed for the economic production of cups out of thermoplastic materials in different shapes and sizes. Frequently the machines are also used as inline systems with pre-linked extruders, e.g. for large-volume production of drinking cups in quantities of millions. The ILLIG IC operating concept also supports the aspects relevant for large-volume production very effectively. Besides mo-

dules used for general process optimization, e.g. the self adaptive start-up (sas-up) during material or mold change, mainly IC modules are employed which ensure high productivity and reliability of a production line and at the same time help to minimize operation costs.

The new SZA 73c stacking machine is suitable for all tasks which so far were performed by three stacking systems: SE 73, SZA 73 and SZS 73. For this purpose the SZA 73c can be equipped variably with different discharge options. When the application changes the discharge system can be easily adjusted thanks to the modular design. The following variants are available: Infinitely per cage or counted per cage, counted in layers or counted in stacks. Existing molds can still be used. Due to the fact that now a servo drive is employed as well, sequencing of forming station and stacking unit can be optimally synchronized.

Thermoforming systems where in the past the performance was limited by the stacking units can now achieve higher productivity with existing molds as well. The SZA 73c performance exceeds the performance of previous versions with speeds of up to 40 cycles per minute achieved with latch stacking and 33 cycles per minute with brush stacking.



*Total granulating solution from Getecha: The large Rotary Cutter granulator RS 6015 (green) with conveying periphery (grey) and cyclone separator (green)*

# "Grinders alone are no longer enough!"

Just in time for the "K" the plant engineering company celebrates its 60-year corporate anniversary

*This autumn the family business Getecha from Aschaffenburg celebrates its 60th anniversary. Having started in a garage in 1956 the company developed over the decades to becoming one of the leading German manufacturers of innovative granulators for the plastics-processing industry. Today Getecha is a business partner on the international scale for the realisation of integrated extraction, granulating and recycling systems with a high degree of automation. Enjoy reading the interview with Burkhard Vogel, Managing Director of Getecha for many years, how the company asserts itself amidst global competition.*





*Getecha Managing Director Burkhard Vogel: "The fact that we have been increasingly sought after for some years now as automating company for production-related extraction, granulation and recycling processed up to ground material delivery and big-bag filling gives us much satisfaction and makes us optimistic!"*

*Mr. Vogel, what makes you most happy in this anniversary year of Getecha?*

**Vogel:** I am proud that we have succeeded in establishing ourselves in Europe as one of the leading manufacturers of energy-efficient granulation solutions for the plastics-processing industry. The fact that we have been increasingly sought after for some years now as automating company for production-related extraction, granulation and recycling processes up to ground material delivery and big-bag filling also gives us satisfaction and makes us optimistic! Both is not to be taken for granted nowadays for a medium-sized plant engineering company based in Germany.

*Which events have decisively influenced this positive development of the company?*

**Vogel:** When our company founder, Ernst Rosenberger, decided to becoming an entrepreneur as young engineer in 1956 he actually intended to focus on pure engineering development in his garage at home and sell some machinery on the side. He did not plan to develop his own production facility at first. But then everything turned out differently. In the early 1960's the first production and assembly hall was built at the current location in Aschaffenburg; a few warehouses were built soon afterwards to optimise procurement logistics. This created the foundation for the business infrastructure for the development and manufacturing of high-performance granulators for the plastics-processing industry.

*Can you tell at which time the change of the company from a pure granulator manufacturer to an automating enterprise with own project engineering began?*

**Vogel:** Yes, the first signs are quite early in the company's history. When in the 1970's the Danish toy maker LEGO asked us to help transfer the sprues from its injection moulding machines directly into granulators, we started with the development and production of fast, electropneumatic sprue pickers and extraction systems. This was the first step to the automating company. Today, thanks to advanced linear and control technology, we realise even highly complex multiple axis systems in this field with excellent positioning and repeat accuracy. Important milestones toward automation, however, were the involvement of the young business generation with Christine and Eva Rosenberger at the end of the 1990's. I joined Getecha in 2002 and took over the position as managing director of sales in April 2004. Two years later we opted for a new logo and modernised our corporate image – especially to underline the new orientation of the company. Since then we do not only advance the development of modular and energy-efficient granulators but are also increasingly discovered by plastics processors as manufacturer of customised, customer-focused granulation and automation solutions.

*Where do you see the strengths of Getecha today – also in regard to distinction against the competition?*

**Vogel:** Only delivering reliable and powerful granulators is by far no longer sufficient today. Customers – whether at home or abroad – meanwhile expect much more. They are looking for a partner who – beyond pure granulation technology – offers custom-tailored and highly automated package solutions, including feeding, removal, conveying, packaging and recirculating systems. Today Getecha is positioned to meeting all these demands. This covers all areas of the plastics-processing industry from injection moulding and thermoforming to blow moulding and plastics recycling. Our major strengths do not only lie in the plant and control technology know-how but also in the intelligent combination of state of the art granulation technology with all kinds of peripheral conveying, handling and packaging systems. This is then the distinguishing feature compared to many competitors.

*Can you observe changes in the relationship between you as plant engineering company and the customers?*

**Vogel:** Yes, we especially observe an increasing division of the customers into two groups. One group only looks at the price in purchasing and puts even quality aspects second. They primarily take advantage of the product offering of companies from Asia. The other, somewhat smaller group, banks on high-quality engineering and focuses more on the added value of a plant engineering package solution taking the comprehensive view of Total Cost of Ownership (TCO) as decision-making basis for their investments. We feel more loyalty between the customers of this group and us



*Involved from the start: The photo shows the booth of Getecha at the K trade fair in 1975*



*Powerful work horse: The large grinding chamber and the oblique rotor of the GRS 300 granulator allow granulating bulky sprues from injection moulding*

and their usually long-term perspective of solid cooperation. This is also based on our self-concept: In spite of all international dimensions in sales, Getecha is a family-based company with a sound basis always available to its customers. Having a huge number of customers is not so critical. Being able to support each customer with sufficient attention necessary to developing a trusting and lasting partnership is much more important to us. Our actions are based on this customer orientation, and we always strive to create true win-win situations.

*Which considerations are guiding you then at this time in your product developments?*

**Vogel:** In the engineering sector we focus especially on the aspects of energy efficiency, environmental compatibility and system integration for our development work. At this time, we are also implementing many ideas from engineering that will reduce the maintenance effort for the customers and further simplify operation of the machines. Many of the current granulators and system components are being modernised accordingly. The flexibility and modularity of our machines constitutes key success factors that encompass all Rotary Cutter model series. Especially these two aspects ensure that we can match each large central and beside-the-press granulator quickly and with little effort individually to the need of the customer – also in regard to their integration into complex package solutions and their linking to the higher level production guidance systems.

*Quiet and efficient: Getecha will introduce new sound-insulated hopper granulators such as the RS 45090 shown here at the K trade fair*

Will you also present innovations in this area at the K plastics trade fair in October?

**Vogel:** I will not give too much information away at this time. Yes, we will come with some innovations for the K in Düsseldorf. They will significantly simplify and improve the integration of our Rotary Cutter granulators in the production lines of our customers.

Concerning the details.... well, trade fair visitors are welcome to take a look for themselves at our booth A21 in hall 9.

Are there policy developments that give reason to concern to you and Getecha management?

**Vogel:** Yes, but they are not new and concern nearly all branches of the industrial landscape. We are latently always concerned about forces that object to the use of plastics categorically without realising the many different ways how these materials simplify our lives today. Campaigns levelled against the plastics industry with slogans such as "plastic bags in the ocean" com-



*These two examples demonstrate the current extent of automation competencies of the plant engineering company Getecha. At the left, a fixture for the automated bonding of foam pads and at the right a complex gripper for a pick&place application*

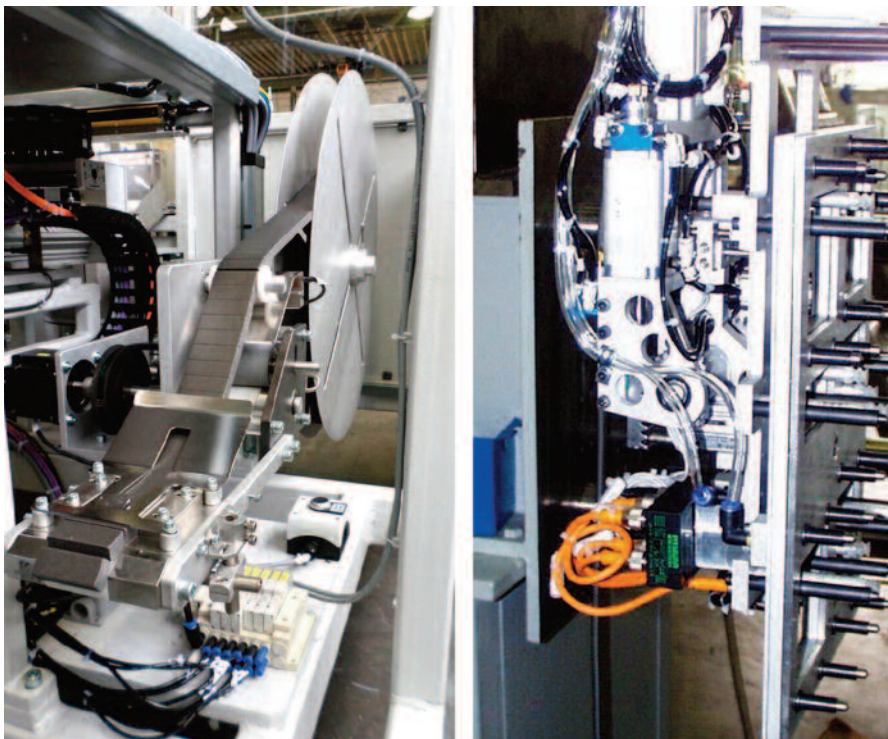

pletely miss the point! The question here is much more: "Who dumped the bag in the ocean?" Such wild types of disposal need to be stopped for good. Everything must focus on recycling all resources into production circulation.

March 2016

#### **Getecha at the K 2016 in Düsseldorf**

Customer-specific granulators for blow moulding production, dust-proof slider granulators for cleanrooms and sound-insulated central granulators for extrusion engineering belong to the trade fair highlights of the plant engineering company Getecha at this year's K in Düsseldorf (19-26 Oct. 2016). In addition, the company provides profound insights into its extraction portfolio at booth A21 in hall 9 and presents a new infeed system for the edge trim preparation in film and plate extrusion.

► [www.getecha.de](http://www.getecha.de)

# Trends and developments in the Asian Flexible Packaging Market



Michael Fischer

*Flexible packaging is a growing market in Asia. Michael Fischer, CEO Asia Pacific at Windmüller & Hölscher, talks about the importance of the Asian market, the trends in the industry and the innovations shown at Chinaplas 2016.*

**Mr. Fischer, Chinaplas 2016 is coming up – how is the market for flexible packaging in Asia-Pacific developing?**

Rising expectation on quality, productivity and sustainability gave a boost to the already growing market of flexible packaging. More and more rigid packaging solutions like glass bottles are being replaced by flexible ones, always considering environmental friendly raw materials to be used. PVC products were replaced by PP and HDPE. These developments fueled the growing importance of the flexible packaging market.

**Which technological trends were especially important during the last years?**

There are a few important developments, especially driven by better price-performance ratios and increasing functionality. Nowadays, 3 and even 5 layer polyolefin structures gained in importance compared to mono extrusion in the past. New raw materials have been developed allowing the down gauging process, by adding different functional layers. At the same time, the overall thickness was reduced, without having lost the technical properties of the packaging material needed. W&H recognized these developments early on and reacted with the design of machines and products strictly according to market needs. With success: The market for W&H in Asia Pacific has grown to a substantial size, especially during the past five years.

**What do you think will be the most relevant trends in the flexible packaging market in Asia in the next few years?**

Improving price-performance ratio as well as flexibility while at the same time offering new functionalities – these goals will continue to be the drivers for upcoming developments. In extrusion, we can clearly see that the machine widths are getting wider: What once used to be 1600 mm has become at least 2200 mm. 5 layer polyolefin products with additional functional layers will continue to replace 3 layer products. When we focus on the final application

we surely can say that breathable film extruded in blown film technology with inline MDO continues to grow fast in Asia. Additionally, the trend of down gauging whilst maintaining unchanged properties keep producers occupied with optimizing their production. Here W&H offers a great experience, because our machines are developed in close relationship with raw material suppliers as well as customers to safeguard the processing of various new materials and to keep the flexibility to react quickly on changing conditions.

**How did W&H develop its offer in the Asian Pacific market during the last years?**

In addition to the innovations and developments of our machines, that we offer our clients worldwide, we have especially focused on customer care and service in the Asian market during the last years. To serve our customers in the Asian Pacific region, we build a strong service team with highest qualification in the region. With approx. 30 mechanics and electricians W&H has started to roll out his service platform in China, Thailand and Australia. They are supported by remote diagnostic centers in India, Germany and the US, to attend service calls 24/7.

**Which innovations will W&H show at Chinaplas?**

We will be focusing on our SQUAREX - upside down water quench - process technology, which is very successful in China. Our new innovation is the latest AQUACAGE. This calibration basket is able to adjust to a flexible film size between 750 and 1250 mm. W&H will also participate at a seminar to speak about barrier film production on occasion of Nippon Goshei's barrier film seminar, which will take place on 26.4.2016 during Chinaplas this year. Benchmarking innovations are also to be expected during forthcoming DRUPA and K shows in Düsseldorf, Germany in May/June and October, later this year.

► [www.wuh-group.com](http://www.wuh-group.com)



# IKV meets the world in Aachen

## 28th International Colloquium Plastics Technology 2016: an international meeting place for the industry

By focusing on topics such as Industry 4.0 in plastics processing, additive manufacturing and lightweight construction, the Institute of Plastics Processing (IKV) in Aachen and the Skilled Crafts at RWTH Aachen University offered a number of important highlights at the recent 28th International Colloquium Plastics Technology in Aachen. The event attracted 825 plastics experts from 24 nations. The keen interest of the delegates, who came from some 300 companies and institutions, underlined the importance of the event as a global meeting place for the plastics segment. The internationalisation of the industry and of plastics research was clearly visible in the audience. The visitors praised the broad content of the presentations and their technical depth – aspects that make the IKV Colloquium such an important highlight.

The Georg Menges prize 2016 was presented to Dipl.-Ing. Hartwig Meier, head of Product and Application Technology at Lanxess Germany, in the presence of Professor em. Georg Menges himself. The prize has been awarded since 1999 by IKV, the VDMA and PlasticsEurope to people who have rendered outstanding service to cooperation between the sciences and economics in the field of plastics processing. Expressing his thanks for the award, Hartwig Meier said: "I have always been fascinated by the challenge of putting to use in production something that has been created in science and research."

A special highlight of the Colloquium was the visit to the IKV laboratories and pilot plants during "IKV 360°". Here, visitors were able to watch live demonstrations of the machines and test

benches and find out more about the Institute's research activities. They also had an opportunity to talk to the IKV research staff about the projects. Another highlight at the event was the official hand-over of the brand-new laboratory for additive manufacturing, which was built as part of the expansion project at the end of 2015.

The accompanying trade show in the Aachen Congress Centre featured the products and services of 46 exhibitors from all areas of the industry. Machine and tool manufacturers, producers of raw materials and peripherals, companies offering instrumentation, control and testing equipment, and providers of software and engineering services showed their latest developments and products, many of which had come about through cooperation with IKV.

"The IKV Colloquium has, for more than 66 years, been the central meeting place for innovative plastics companies. The internationalisation of the Colloquium goes hand in hand with the internationalisation strategy at IKV, and thus accurately reflects what is currently shaping our plastics segment. The Colloquium can thus be regarded as lubricating the interplay between science and industry, producing the leaders and innovations of tomorrow," said the head of IKV, Professor Christian Hopmann, summing up.

*The next colloquium will be held on 28 February and 1 March, 2018 in Aachen.*

► [www.ikv-aachen.de](http://www.ikv-aachen.de)

- Compounding, masterbatches
- Material handling and peripheral equipment
- Extrusion incl. film extrusion
- PVC processing
- Packaging
- Raw materials, auxiliaries
- Recycling
- Injection moulding technology

- round tables and discussions
- practical solutions for resources savings
- cases from companies-converters of plastics
- tendencies and innovations in the plastics industry
- recommendations of technical consultants from companies developers of the machinery
- widespread problems of converters and ways of their decision

Organizers:



EXTRUSION

iptf.ru

Annual meeting of technologists and engineers of the plastic converters companies with suppliers of the equipment and raw materials

## Facts about IPTF

### IPTF 2015 Sponsors:



Small selection of companies that participated in IPTF 2013-2015:



## Statistic of the IPTF in diagram

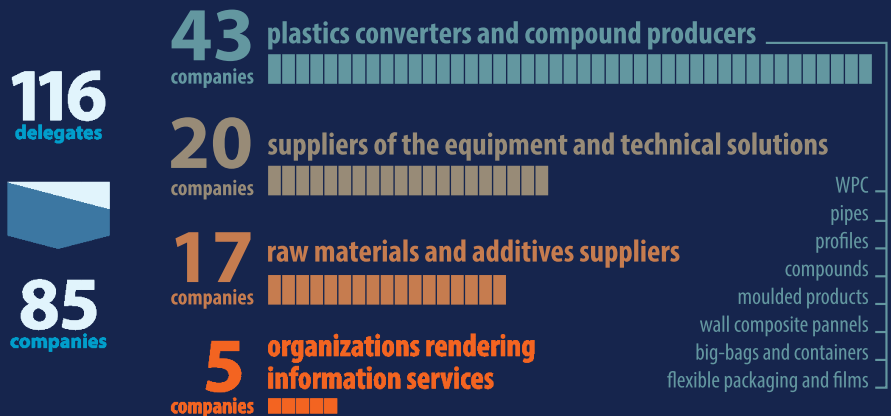

Organizers contacts:

Sponsor package price:

3 500 €

in Russia: +7 499 346 68 47

in Ukraine:  
+38 098 122 62 34  
+38 056 790 17 34  
info@iptf.ru  
Skype: pan\_stasyan

in Germany:  
VM Verlag GmbH  
+49 178 877 9313  
+49 06226 971515  
redaktion@vm-verlag.com

IPTF 2016 sponsored by:

